

# NEWS 2022

THE GOOD LIVING



Rimadesio

EN WITH THE GOOD LIVING RIMADESIO'S SPECIAL DESIGN IDEA IS PRESENTED, WHERE TECHNOLOGY, RESEARCH INTO MATERIALS AND PRODUCTION CHOICES PLAY A FUNDAMENTAL ROLE. A DESIGN SUGGESTIVE OF A NEW LIFESTYLE, AN IDEAL SOLUTION TO ACHIEVE A BETTER BALANCE BETWEEN THE EMOTION OF LIVING AND THE RELATIONSHIP WITH THE ENVIRONMENT IN WHICH WE LIVE.

IT CON THE GOOD LIVING VA IN SCENA LA PARTICOLARE IDEA DI DESIGN RIMADESIO, IN CUI TECNOLOGIA, RICERCA SUI MATERIALI E SCELTE PRODUTTIVE SVOLGONO UN RUOLO FONDAMENTALE. UN DESIGN CHE SUGGERISCE UN NUOVO STILE DI VITA, UNA DIMENSIONE IDEALE, TESA AD UN MIGLIORE EQUILIBRIO TRA L'EMOZIONE DELL'ABITARE E IL RAPPORTO CON L'AMBIENTE IN CUI VIVIAMO.

LIVING	
STRIPE, ZENIT, MODULOR, SELF PLAN	7
DINING	
MODULOR, RADIUS, ALIANTE, FRANCIS	31
NIGHT	
SELF PLAN, SELF BOLD, RADIUS, PLANET	43
WALK-IN CLOSET	
ZENIT, COVER	53
TECHNICAL DATA	
TAIGA, NEW FINISHING	65
RADIUS	69
SELF	81
ZENIT BOOKCASE	89
ZENIT WALK-IN CLOSET	95
COVER	101
ALIANTE	107
MATERIALS AND FINISHINGS	113
TEXTS	117

# STRIPE, ZENIT, MODULOR, SELF PLAN

EN RIGOROUSLY DESIGNED WITH PRECIOUS MATERIALS, STRIPE SLIDING DOORS FORM A PRACTICAL SCREEN BETWEEN THE HOUSE ENTRANCE AREA AND THE LARGE, BRIGHT LIVING AREA. HERE, ON THE OPPOSITE SIDES OF THE SOFA AREA, A ZENIT BOOKCASE AND A SELF PLAN WALL-HUNG STRUCTURE FACE EACH OTHER. PLAYING MUTUALLY COMPLEMENTARY FUNCTIONS, THE SYSTEMS HELP TO DEFINE THE COMPOSITIONAL ORDER AND STYLISTIC MODERNITY THAT CHARACTERISE THE SPACE.

IT RIGOROSE NEL DISEGNO E PREZIOSE NEI MATERIALI, LE ANTE SCORREVOLI STRIPE COSTITUISCONO UN PRATICO SCHERMO TRA L'AMBIENTE D'INGRESSO DELLA CASA E L'AMPIA E LUMINOSA AREA LIVING. QUI, SUI LATI OPPOSTI DELLA ZONA DIVANI, SI FRONTEGGIANO UNA LIBRERIA INTERPARETE ZENIT E UNA COMPOSIZIONE SOSPESA A PARETE SELF PLAN. TRA LORO COMPLEMENTARI SUL PIANO FUNZIONALE, I SISTEMI CONTRIBUISCONO A DEFINIRE L'ORDINE COMPOSITIVO E LA MODERNITÀ STILISTICA CHE CARATTERIZZANO LO SPAZIO.







EN The Rimadesio materials collection is enriched with two new types of wood: oak and ebony-stained: oak and ebony-stained, both available in the new taiga finish. The surface is marked by a finely striped horizontal texture, obtained through a mechanical pressing process that gives the material a three-dimensional relief that is soft to the touch. In both essences, the taiga finish is available on 15 products in the collection: from the sideboards to the hinged doors, from the doors of the night storage units to the panels of the Modulor paneling system.

IT La collezione materiali Rimadesio si arricchisce di due nuove essenze: rovere e tinto ebano, entrambe disponibili nell'inedita finitura taiga. La superficie è scandita da una texture orizzontale finemente rigata, ottenuta con un processo di pressatura meccanica che dona alla materia un rilievo tridimensionale, morbido al tatto. In entrambe le essenze, la finitura taiga è disponibile su 15 prodotti della collezione: dalle madie alle porte battenti, dalle ante dei contenitori notte ai pannelli del sistema boiserie Modulor.

DE Die Materialauswahl von Rimadesio wird durch zwei neue Hölzer bereichert: Eiche und Ebenholz gebeizt, beide in der noch nie dagewesenen Taiga-Ausführung erhältlich. Die Oberfläche ist durch eine fein gerippte horizontale Struktur gekennzeichnet, die durch ein mechanisches Pressverfahren erzielt wird, das dem Material ein dreidimensionales Relief mit weichem Hautgefühl verleiht. In beiden Holzarten ist das Taiga-Finish für 15 Produkte der Kollektion erhältlich: von Sideboards bis zu Flügeltüren, von den Türen der Nachtschränke bis zu den Paneelen des Modulor-Verkleidungssystems.

FR La collection Rimadesio s'enrichit de deux nouvelles essences : chêne et teinte ébène, toutes deux sont disponibles dans la nouvelle finition taiga. La surface est marquée par une texture horizontale finement rayée, obtenue par un procédé de pressage mécanique qui donne au matériau un relief tridimensionnel, doux au toucher. La finition taiga est disponible dans les deux essences sur 15 produits de la collection: des bahut aux portes battantes, aux portes des bloc toirs pour la zone nuit et aux panneaux du système de boiserie Modulor.

ES La colección de materiales Rimadesio se enriquece con dos nuevos revestimientos: roble y acabado ebano, ambos disponibles en la nueva versión taiga. La superficie presenta una textura horizontal finemente rayada, obtenida mediante un proceso de prensado mecánico que confiere al material un relieve tridimensional suave al tacto. El acabado taiga está disponible para ambas maderas en 15 productos de la colección: desde aparadores hasta puertas batientes, desde puertas de los contenedores de noche hasta paneles del sistema de boiserie Modulor.

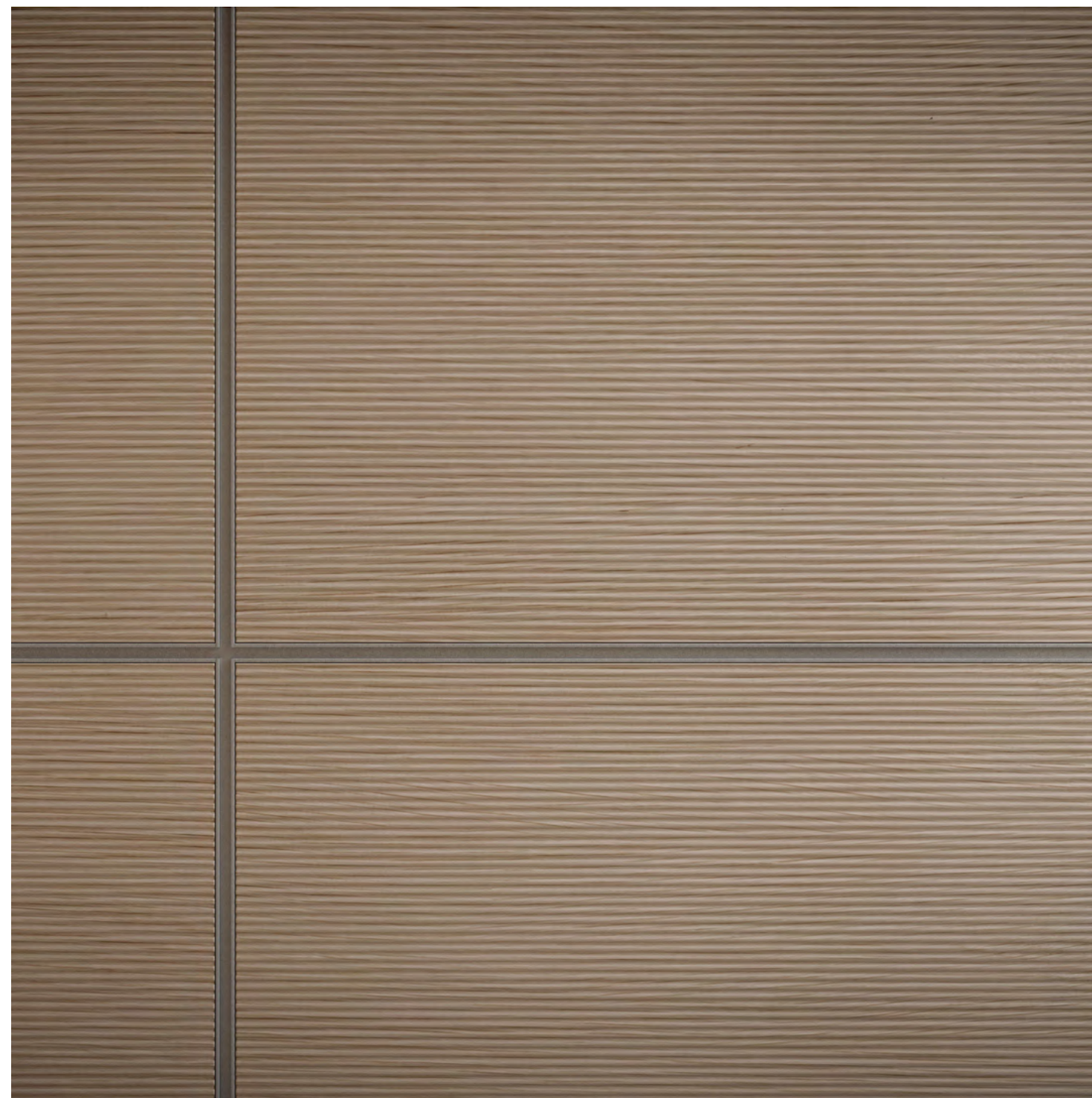





EN In the bookcase version, Zenit now expands its design potential with the introduction of a brand new backlit upright and new suspended units which, like all Zenit facilities, can be freely positioned. The new design includes a chest of drawers, a unit with doors, a chest of drawers with bottom-hinged frame. With their fully extractable runners, the aluminium drawers are also new and come equipped with a unique push opening system and soft-closing mechanism. The drawer and door coating is available in glossy, opaque, reflex, sahara, diamond lacquered glass or in Litech or Sahara and Taiga essence with three-dimensional effect, for a total of 161 finishes. The unit D 340 with bottom-hinged frame is lined inside with synthetic leather in 7 available finishes: Arena, Nube, Argilla, Castoro, Rubens, Etna and Agata.

IT Nella versione libreria Zenit amplia oggi le proprie potenzialità progettuali con l'introduzione di un inedito montante retroilluminato e di nuovi contenitori sospesi che, come tutte le attrezzature di Zenit, sono liberamente posizionabili. La nuova proposta comprende: cassetiera, contenitore con ante, cassetiera con anta ribalta e cassetto. Nuovi anche i cassetti in alluminio, con guide ad estrazione totale e dotati di un inedito sistema di apertura push e rientro ammortizzato. Il rivestimento dei cassetti e delle ante è disponibile in vetro laccato lucido, opaco, reflex, sahara, diamante oppure in Litech, in essenza Sahara e Taiga con effetto tridimensionale, per un totale di 161 finiture. Il contenitore con anta a ribalta P 340 è rivestito internamente in similpelle nelle 7 finiture previste: Arena, Nube, Argilla, Castoro, Rubens, Etna e Agata.

DE In der Ausführung als Bücherregal erweitert Zenit nun sein Gestaltungspotenzial durch die Einführung einer noch nie dagewesenen hinterleuchteten Basis und neuer Hängeschränke, die, wie alle Zenit-Einrichtungen, frei positioniert werden können. Das neue Angebot umfasst: Kommode, Schrank mit Türen, Kommode mit Klapptür und Schublade. Neu sind auch die Aluminium-Schubladen mit Vollauszug, die mit einem neuartigen Push-Open-System und Soft-Close-Rückführung ausgestattet sind. Die Paneele der Schubladen und Türen sind in glänzend oder matt lackiertem Glas, in Reflex, Sahara und Diamant oder in Litech, Sahara- und Taigaholz mit dreidimensionalem Effekt erhältlich, insgesamt stehen 161 Ausführungen zur Verfügung. Das Klapptürelement in Tiefe 340 wird innen mit Kunstleder in den 7 verfügbaren Ausführungen Arena, Nube, Argilla, Castoro, Rubens, Etna oder Agata gepolstert.

FR Dans sa version bibliothèque, Zenit élargit désormais son potentiel de conception avec l'introduction d'un montant rétroéclairé inédit et de nouveaux caissons suspendus qui, comme tous les équipements de Zenit, peuvent être librement positionnés. La nouvelle offre comprend: bloc tiroirs, caisson avec portes, élément avec abattant et tiroir. Autre nouveauté également, les tiroirs en aluminium qui disposent de glissières entièrement extractibles et sont équipés d'un système inédit d'ouverture push-pull avec amortisseur de fermeture. Le revêtement des tiroirs et des portes est disponible en verre laqué brillant, opaque, reflex, sahara, diamant ou en Litech, en essence Sahara et Taiga avec effet 3D, avec un choix parmi 161 finitions. L'intérieur du élément avec abattant P 340 est recouvert de similicuir disponible en 7 finitions: Arena, Nube, Argilla, Castoro, Rubens, Etna et Agata.

ES En su versión de librería, Zenit amplía ahora su potencial de diseño espacial con la introducción de un inedito elemento vertical retroiluminado y nuevos contenedores suspendidos que, como todos los productos de Zenit, se pueden colocar libremente. La nueva propuesta incluye: cajonera, contenedor con puertas, cajonera con puerta abatible y cajón. De igual forma son nuevos los cajones de aluminio, con guías totalmente extraíbles y dotados de un inedito sistema de apertura push y retorno amortiguado. El revestimiento de cajones y puertas está disponible en vidrio lacado brillante, opaco, reflex, sahara, diamante o en Litech, en modelos Sahara y Taiga con efecto tridimensional, para un total de 161 acabados. El contenedor con puerta abatible P 340 está revestido internamente en similpiel en los 7 acabados previstos: Arena, Nube, Arcilla, Castor, Rubens, Etna y Agata.



ZENIT  
struttura/structure: 206 bronzo graffiato  
frontali cassettiere/frontal drawers: 701 rovere taiga  
interni/internal: UB09 melaminico cuoio brown







ZENIT  
struttura/structure: 206 bronzo graffiato  
frontali/fronts: 701 rovere taiga  
interni/internal: UB09 melaminico cuoio brown





ZENIT  
 struttura/structure: 206 bronzo graffiato  
 frontali/fronts: 701 rovere taiga  
 piano interno in similpelle/synthetic leather  
 internal door cladding top: 154 argilla  
 schienale interno/back internal: 68 specchio grigio

# MODULOR, RADIUS, ALIANTE, FRANCIS



EN PRESENT BOTH ON THE MODULOR PANELING AND ON THE RADIUS DOORS, THE NEW TAIGA OAK FINISH EMBELLISHES YOUR DINING ROOM WITH ITS DELICATE GRAPHIC DESIGN. THE ROUND VERSION OF THE FRANCIS TABLE OCCUPIES THE CENTRE OF THE SPACE, WHILE TWO ALIANTE GLASS SIDEBOARDS EMPHASISE THE SYMMETRICAL LAYOUT ON THE SIDES. THE RESULT IS A BRIGHT AND COHESIVE ENVIRONMENT, WHERE NOTHING IS LEFT TO CHANCE - BE IT THE REFINED DESIGN OF THE VARIOUS FURNISHING COMPONENTS, THE TECHNICAL AND FUNCTIONAL QUALITY OF THE OPENING MOVEMENTS, OR THE SOPHISTICATED COMBINATION OF MATERIALS AND FINISHES.

IT PRESENTE SIA SULLA BOISERIE MODULOR CHE SULLE PORTE RADIUS, LA NUOVA FINITURA ROVERE TAIGA IMPREZIOSISCE L'AMBIENTE DINING CON IL SUO DELICATO DISEGNO GRAFICO. IL TAVOLO FRANCIS IN VERSIONE TONDA OCCUPA IL CENTRO DELLO SPAZIO, MENTRE AI LATI DUE MADIE IN VETRO ALIANTE NE SOTTOLINEANO L'IMPIANTO SIMMETRICO. IL RISULTATO È UN AMBIENTE LUMINOSO E COERENTE, IN CUI NULLA È CASUALE: DAL DESIGN RICERCATO DEI DIVERSI COMPONENTI D'ARREDO ALLA QUALITÀ TECNICA E FUNZIONALE DEI MOVIMENTI DI APERTURA, FINO ALLA SOFISTICATA COMBINAZIONE DEI MATERIALI E DELLE FINITURE.





EN Aliante appears as a precious transparent glass cabinet with an original opening system. It is a cabinet with rigorous proportions, which concentrates a series of exclusive technical solutions. These include the special opening of the doors which, with a thin aluminium structure and a special glass assembly technique, exclude the presence of lateral flanks and give the container an extraordinary light and transparent image.

IT Aliante si presenta come uno scrigno prezioso in vetro trasparente, dotato di un inedito sistema di apertura. Un contenitore dalle proporzioni rigorose, che concentra una serie di soluzioni tecniche esclusive. Come la particolare apertura delle ante che, dotate di una sottile struttura in alluminio e di una speciale tecnica di assemblaggio del vetro, escludono la presenza di fianchi laterali e conferiscono al contenitore un'immagine straordinariamente leggera e trasparente.

DE Aliante sieht aus wie eine kostbare transparente Glasschatulle, die mit einem beispiellosen Öffnungssystem ausgestattet ist. Ein Behälter mit rigorosen Proportionen, der eine Reihe exklusiver technischer Lösungen konzentriert. Wie die besondere Öffnung der Türen, die, ausgestattet mit einer dünnen Aluminiumstruktur und einer speziellen Glasmontagetechnik, das Vorhandensein von Seitenwänden ausschließt und dem Container ein außergewöhnlich leichtes und transparentes Aussehen verleiht.

FR Aliante se présente comme un écrin précieux en verre transparent, doté d'un système d'ouverture inédit. Un caisson aux proportions rigoureuse qui concentre une série de solutions techniques exclusives. Comme l'ouverture particulière des vantaux, dotés d'une fine structure en aluminium et d'une technique d'assemblage spéciale du verre, excluent la présence des côtés et apportent au caisson une image extraordinairement légère et transparente.

ES Aliante tiene el aspecto de un precioso cofre de cristal transparente, equipado con un sistema de apertura inédito. Un contenedor de proporciones rigurosas, que concentra una serie de soluciones técnicas exclusivas. Como la especial apertura de las puertas, dotadas de una fina estructura de aluminio y de una técnica especial de montaje del cristal, que excluye la presencia de paneles laterales y confiere al contenedor una imagen extraordinariamente ligera y transparente.



#### ALIANTE

struttura/structure: 303 bronzo  
vetro/glass: 67 riflettente chiaro  
ripiani interni in vetro/glass internal shelves:  
63 grigio trasparente  
top cassetiera in similpelle/

synthetic leather lower top: 154 argilla  
basamento, top, cassetiera e schienale/  
base, top, drawer unit and back panel:  
19 rovere termotrattato (non disponibile  
a listino/not available in the price list)

Nella foto/In this photo:  
boiserie/wall paneling system: Modulor



ALIANTE

struttura/structure: 303 bronzo  
 vetro/glass: 67 riflettente chiaro  
 ripiani interni in vetro/glass internal shelves:  
 63 grigio trasparente  
 top cassetiera in similpelle/

synthetic leather lower top: 154 argilla  
 basamento, top, cassetiera e schienale/  
 base, top, drawer unit and back panel:  
 19 rovere termotrattato (non disponibile  
 a listino/not available in the price list)

Nella foto/In this photo:  
 boiserie/wall paneling system: Modulor



RADIUS  
struttura/structure: 304 platino  
pannello porta/door panel: 701 rovere taiga

MODULOR  
struttura/structure: 304 platino  
rivestimento/cladding: 701 rovere taiga

SELF PLAN, SELF BOLD,  
RADIUS, PLANET

EN ENRICHED BY A LARGE WRITING DESK, A SELF PLAN STRUCTURE SUGGESTS A DIFFERENT WAY OF EXPERIENCING NIGHT SPACES. ESSENTIAL AND DISCREET, TWO PLANET LOW TABLES SERVE THE BED, WHILE THE RADIUS DOORS IN THE SYNTHETIC LEATHER VERSION CONNECT THE SPACE TO THE WARDROBE AREA. TOGETHER WITH THE SPECIFIC FUNCTION, EACH PIECE OF FURNITURE HELPS TO CREATE A COHESIVE WHOLE – IN THE COLOURS AND TEXTURES OF THE MATERIALS, IN THE MINIMALISM OF THE DESIGN AND IN THE ATTENTION TO EVERY DETAIL.

IT ARRICCHITA DA UN AMPIO PIANO SCRITTOIO, UNA COMPOSIZIONE SELF PLAN SUGGERISCE UNA FORMA DIVERSA DI VIVERE LO SPAZIO NOTTE. ESSENZIALI E DISCRETI, DUE TAVOLI BASSI PLANET SONO DI SERVIZIO AL LETTO, MENTRE LE PORTE RADIUS IN VERSIONE SIMILPELLE COLLEGANO LO SPAZIO ALLA ZONA ARMADI. INSIEME ALLA FUNZIONE SPECIFICA, OGNI COMPONENTE D'ARREDO CONTRIBUISCE A DEFINIRE UN INSIEME COERENTE, NELLE CROMIE E NELLE TEXTURES DEI MATERIALI, NELL'ESSENZIALITÀ DEL DISEGNO E NELLA CURA DI OGNI DETTAGLIO.





SELF PLAN  
struttura/structure: 303 bronzo  
piano e schienale in similpelle/synthetic  
leather top and back panel: 154 argilla  
vano a giorno/open module:  
19 rovere termotrattato

SELF BOLD  
struttura/structure: 303 bronzo  
vetro/glass: 403 bronzo diamante

Nella foto/In this photo:  
tavolino/coffee table: Planet



EN Always made to measure in height and width, Radius is available in large dimensions, with panels that reach 3600 mm in height and 1760 mm in width. This is thanks to an extruded aluminium structure designed to give maximum strength and stability in domestic as well as professional, hospitality and retail.

IT Realizzata sempre su misura in altezza e larghezza, Radius è capace di declinarsi su grandi dimensioni, con pannelli che raggiungono 3600 mm in altezza e 1760 mm in larghezza grazie a una struttura in alluminio estruso progettata per conferire massima resistenza e stabilità in contesti domestici oltre che professionali, hospitality e retail.

DE Radius wird in Höhe und Breite immer nach Maß gefertigt und kann dank einer Struktur aus stranggepresstem Aluminium, die auf maximale Festigkeit und Stabilität ausgelegt ist, in großen Formaten mit einer Höhe bis zu 3600 mm und einer Breite bis zu 1760 mm angeboten werden sowohl im häuslichen als auch im beruflichen Kontext, Gastgewerbe und Einzelhandel.

FR Toujours réalisé sur mesure en hauteur et en largeur, Radius peut être décliné en grandes dimensions, avec des panneaux atteignant 3600 mm de hauteur et 1760 mm de largeur, grâce à une structure en aluminium extrudé conçue pour apporter un maximum de résistance et de stabilité dans les contextes domestiques et professionnels, de l'hôtellerie et de la vente au détail.

ES Siempre a medida en altura y anchura, Radius se adapta a grandes espacios, con paneles que alcanzan los 3600 mm de altura y los 1760 mm de anchura, gracias a una estructura de aluminio extruido diseñada para ofrecer una resistencia y estabilidad máximas en contextos domésticos y profesionales, hospitality y retail.



EN Made entirely of aluminium, Self plan is based on horizontal modularity, with a fixed depth of 525 mm and a variable length from 1,616 to 3,856 mm. Wide variety of finishes: the aluminium structure is available in 46 Ecolorsystem colours. In the desk version, the top and the rear riser can be made of glass or synthetic leather, for a total of 106 finishes.

IT Realizzato interamente in alluminio, Self plan è basato su una modularità orizzontale, con profondità fissa di 525 mm e una lunghezza variabile da 1616 a 3856 mm. Ampia la varietà di finiture: la struttura in alluminio è disponibile in 46 colori Ecolorsystem. Nella versione scrittoio, il piano e l'alzata posteriore possono essere realizzati in vetro o similpelle, per un totale di 106 finiture.

DE Self Plan ist vollständig aus Aluminium gefertigt und basiert auf einer horizontalen Modularität, mit einer festen Tiefe von 525 mm und einer variablen Länge von 1616 bis 3856 mm. Es gibt eine große Auswahl an Oberflächen: Die Aluminiumstruktur ist in 46 Ecolorsystem-Farben erhältlich. Bei der Schreibtischversion können die Platte und die hintere Setzstufe aus Glas oder Kunstleder gefertigt werden, sodass insgesamt 106 Oberflächen zur Verfügung stehen.

FR Réalisé entièrement en aluminium, Self plan repose sur une modularité horizontale, avec une profondeur fixe de 525 mm et une longueur variable de 1616 à 3856 mm. Grande diversité de finitions : la structure en aluminium est disponible en 46 couleurs Ecolorsystem. Dans la version bureau, le plateau et la partie constituant le fond peuvent être en verre ou en similicuir, avec un choix parmi 106 finitions.

ES Realizada íntegramente en aluminio, Self plan se basa en una modularidad horizontal, con una profundidad fija de 525 mm y una longitud variable de 1616 a 3856 mm. La variedad de acabados es amplia: la estructura de aluminio está disponible en 46 colores Ecolorsystem. En la versión de escritorio, el plano horizontal y la parte posterior pueden realizarse en cristal o simipiel, con un total de 106 acabados.



SELF PLAN  
struttura/structure: 303 bronzo  
piano e schienale in similpelle/synthetic  
leather top and back panel: 154 argilla  
vano a giorno/open module:  
19 rovere termotrattato

SELF BOLD  
struttura/structure: 303 bronzo  
vetro/glass: 403 bronzo diamante

# ZENIT, COVER

EN FRAMED BY COVER WARDROBE CURTAIN WALLS, THE WARDROBE SPACE FEATURES A ZENIT STRUCTURE IN THE CENTRE, HERE IN THE WALK-IN CLOSET VERSION. THE BRIGHT ARENA SYNTHETIC LEATHER OF THE COVER DOORS THUS FORMS THE BACKGROUND TO THE RIGOROUS BRONZE FINISH ZENIT ALUMINUM, WHILE THE LATTER'S FIXTURES - UPDATED WITH RESPECT TO THE MOST RECENT VERSION - MEETS THE TYPICAL ORGANISATION NEEDS OF VARIOUS FUNCTIONS IN AN ORIGINAL WAY.

IT INCORNICIATO DA PARETI CONTINUE DI ARMADI COVER, LO SPAZIO GUARDAROBA PRESENTA AL CENTRO UNA COMPOSIZIONE ZENIT, QUI NELLA VERSIONE CABINA ARMADIO. LA LUMINOSITÀ DELLA SIMILPELLE ARENA DELLE ANTE DI COVER FA COSÌ DA SFONDO AL RIGORE DELL'ALLUMINIO IN FINITURA BRONZO DI ZENIT, MENTRE LE ATTREZZATURE DI QUEST'ULTIMA, AGGIORNATE RISPETTO ALLA PIÙ RECENTE VERSIONE, RISOLVONO CON ORIGINALITÀ LE TIPICHE ESIGENZE DI ORGANIZZAZIONE DELLE DIVERSE FUNZIONI.



EN The Zenit walk-in closet expands its design potential with the introduction of an exclusive range of modular drawer units, made with the latest production technologies for processing extruded and sheet aluminium. The drawers, coated inside with fabric or synthetic leather, are available in three widths, two heights and four aesthetic versions to meet highly personal demands concerning the organisation of walk-in closets: open drawer without front, drawer with glass front, drawer with lacquered front and drawer with synthetic leather front. The drawers, made of extruded aluminium, are characterised by their thin thickness of only 8 mm and the exclusive 'folding' processing without joints on the edges.

IT La cabina armadio Zenit amplia le proprie potenzialità progettuali con l'introduzione di un esclusivo programma di cassetiere modulari e componibili, realizzate con le più recenti tecnologie produttive per la lavorazione dell'alluminio estruso ed in lastra. I cassetti, rivestiti internamente in tessuto o similpelle, sono disponibili in tre larghezze, due altezze e in quattro versioni estetiche per rispondere alle esigenze più personali nell'organizzazione della cabina armadio; cassetto aperto senza frontale, cassetto con frontale in vetro, cassetto con frontale laccato e cassetto con frontale in similpelle. I cassetti, realizzati in alluminio estruso, sono caratterizzati dallo spessore sottile di soli 8 mm e dall'esclusiva lavorazione "folding" senza giunzioni sugli spigoli.

DE Der begehbare Kleiderschrank Zenit erweitert seine Gestaltungsmöglichkeiten mit der Einführung eines exklusiven Programms von modularen und kombinierbaren Schubladenelementen, die mit den neuesten Produktionstechnologien zur Verarbeitung von stranggepresstem Aluminium und Aluminiumblech hergestellt werden. Die innen mit Stoff oder Kunstleder bezogenen Schubladen sind in drei breiten, zwei höhen und in vier ästhetischen Ausführungen erhältlich, um auch die individuellsten Bedürfnisse bei der Organisation des begehbaren Kleiderschranks zu erfüllen: offene Schublade ohne Front, Schublade mit Glasfront, Schublade mit lackierter Front oder mit Kunstlederfront. Die aus stranggepresstem Aluminium gefertigten Schubladen zeichnen sich durch ihre geringe Stärke von nur 8 mm und die einzigartige „Folding“-Verarbeitung ohne Verbindungsstellen an den Kanten aus.

FR Le dressing Zenit élargit son potentiel de conception avec l'introduction d'un programme exclusif de blocs de tiroirs modulables, réalisés avec les dernières technologies de production pour le traitement de l'aluminium extrudé et en tôle. Les tiroirs, dont l'intérieur est revêtu de tissu ou de similicuir, sont disponibles en trois largeurs, deux hauteurs et en quatre versions esthétiques pour répondre aux exigences de chacun pour l'organisation du dressing ; tiroir ouvert sans façade, tiroir avec façade en verre, tiroir avec façade laquée. Réalisés en aluminium extrudé, les tiroirs se caractérisent par une fine épaisseur de 8 mm seulement et par un procédé exclusif de « pliage » sans joints sur les angles.

ES El vestidor Zenit amplía su potencial de diseño con la introducción de un programa exclusivo de cajoneras modulares y componibles, fabricadas con las últimas tecnologías de producción del aluminio extruido y en placas. Los cajones, revestidos interiormente en tejido o simil cuero, están disponibles en tres anchos, dos alturas y en cuatro versiones estéticas para satisfacer las necesidades más personales relativas a la organización del vestidor: bandeja sin frente, cajón con frente de cristal, cajón con frente lacado y cajón con frente de simil cuero. Los cajones, fabricados en aluminio extruido, se caracterizan por un fino espesor de solo 8 mm y el exclusivo proceso "folding" sin juntas en los bordes.



ZENIT  
struttura/structure: 303 bronzo  
rivestimento interno in similpelle/synthetic  
leather internal cladding: 157 arena  
top e frontale in vetro/glass top and drawer  
front: 63 grigio trasparente



ZENIT  
struttura/structure: 303 bronzo  
rivestimento interno in similpelle/synthetic  
leather internal cladding: 157 arena  
top e frontale in vetro/glass top and drawer  
front: 63 grigio trasparente

COVER FREESTANDING  
struttura/structure: 303 bronzo  
ante e accessori/doors and accessories:  
157 similpelle arena

EN The Cover closing system, also in the Freestanding version, continues its stylistic evolution which is all about lightness and formal linearity. The new hinged door is equipped with horizontal aluminium crosspieces that punctuate the wardrobe, enhancing the coating. A modular and always tailor-made solution, designed to organise spaces and create storage elements, compartments and equipped wardrobes that combine functional design and aesthetic refinement. All the doors are retro-finished with a lacquered aluminium panel matching the structure and equipped with magnetic closure.

IT Il sistema di chiusura Cover, anche nella versione Freestanding, prosegue la propria evoluzione stilistica all'insegna della leggerezza e della linearità formale. La nuova anta battente è dotata di traversi orizzontali in alluminio che ritmano l'armadiatura valorizzandone il rivestimento. Una soluzione componibile e sempre su misura, progettata per organizzare gli spazi, creando elementi contenitore, vani di passaggio e guardaroba attrezzati che associano design funzionale e ricercatezza estetica. Tutte le ante sono retrofinito con un pannello in alluminio laccato in tinta alla struttura e dotate di chiusura magnetica.

DE Das Verschlussystem Cover setzt auch in der freistehenden Version seine stilistische Entwicklung im Zeichen von Leichtigkeit und formaler Geradlinigkeit fort. Die neue Flügeltür hat horizontale Aluminium-Querstreben, die dem Schranksystem einen Rhythmus geben und die Verkleidung aufwerten. Eine kombinierbare, stets maßgeschneiderte Lösung zur Organisation von Räumen, die Fächerelemente, Durchgänge und ausgestattete Garderoben schafft, welche funktionelles Design und ästhetische Raffinesse miteinander verbinden. Alle Türen sind mit einer auf den Rahmen abgestimmten, lackierten Aluminiumplatte hinterlegt und mit einem Magnetverschluss versehen.

FR Le système de fermeture Cover, également dans la version Freestanding, poursuit son évolution stylistique sous le signe de la légèreté et de la linéarité formelle. La nouvelle porte battante est équipée de traverses horizontales en aluminium qui rythment l'armoire et mettent en valeur son revêtement. Une solution modulaire et toujours sur mesure, conçue pour organiser les espaces, en créant des éléments de rangement, des espaces pour le passage et des armoires équipées qui allient design fonctionnel et raffinement esthétique. Toutes les portes sont finies à l'arrière avec un panneau en aluminium laqué assorti à la structure et dotées d'une fermeture magnétique.

ES El sistema de cierre Cover, también en la versión Freestanding, continúa su evolución estilística basada en la ligereza y la linealidad en las formas. La nueva hoja batiente está equipada de travesaños horizontales de aluminio que dinamizan el armario realizando el revestimiento. Una solución modular y siempre a medida, pensada para organizar espacios, creando elementos de almacenamiento, zonas de paso y armarios equipados que combinan diseño funcional y refinamiento estético. Todas las puertas están dotadas de cierre magnético y revestidas en la parte posterior con un panel de aluminio lacado a juego con la estructura.

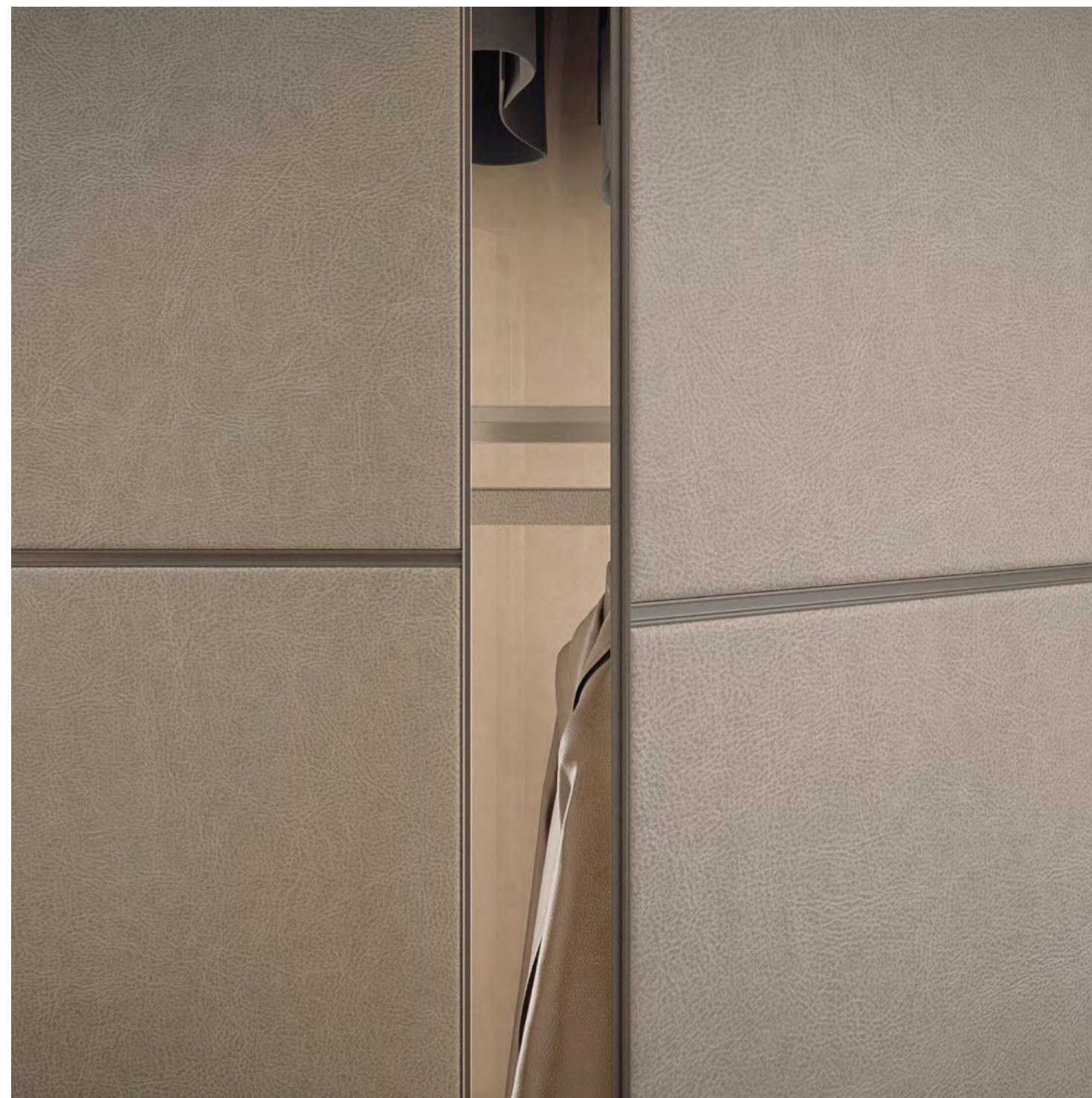

COVER FREESTANDING  
struttura/structure: 303 bronzo  
porte e accessori in similpelle/synthetic  
leather doors and accessories: 157 arena

# TECHNICAL DATA



## TAIGA, NEW FINISHING

EN The exclusive range of Rimadesio materials is being enriched with two new essences: oak and stained ebony, both available in the brand new taiga finish. The surface is marked by a finely striped horizontal texture, obtained through an innovative mechanical pressing process that gives the material a three-dimensional relief, soft to the touch. With its rigorous and elegant geometry, the taiga finish is able to enhance both the light shades of the oak and the dark tones of the stained ebony essence.

IT L'esclusiva gamma di materiali Rimadesio si arricchisce di due nuove essenze: rovere e tinto ebano, entrambe disponibili nell'inedita finitura taiga. La superficie è scandita da una texture orizzontale finemente rigata, ottenuta mediante un innovativo processo di pressatura meccanica che dona alla materia un rilievo tridimensionale, morbido al tatto. Con la sua geometria rigorosa ed elegante, la finitura taiga è in grado di valorizzare sia le sfumature chiare del rovere sia i toni scuri dell'essenza tinto ebano.

DE Rimadesio's exklusive Materialauswahl wurde um zwei neue Holzoberflächen erweitert. Rovere und Tinto Ebano, beide verfügbar in der neuen Ausführung Taiga. Diese Oberfläche ist durch eine horizontale Riffelung gekennzeichnet, hergestellt durch ein innovatives mechanisches Pressverfahren, welche dem Material eine dreidimensionale Wirkung und eine weiche Haptik verschafft. Mit ihrer rigoros eleganten Geometrie ist die Ausführung Taiga in der Lage sowohl der Maserung der Eiche, als auch den dunklen Tönen des Holzfurniers Tinto Ebano die entsprechende Wertigkeit zu geben.

FR La gamme exclusive de matériaux Rimadesio s'enrichit de deux nouvelles essences: chêne et teinté ébène, toutes deux disponibles dans la toute nouvelle finition taïga. La surface est marquée par une texture horizontale finement ondulée, obtenue grâce à un procédé de pressage mécanique innovant qui donne au matériau un relief tridimensionnel, doux au toucher. Avec sa géométrie rigoureuse et élégante, la finition taïga est capable de mettre en valeur à la fois les nuances claires du chêne et les tons sombres de l'essence teintée ébène.

ES La exclusiva gama de materiales Rimadesio se enriquece con dos nuevas maderas: roble y teñido ébano, ambas disponibles en el nuevo acabado taiga. La superficie está marcada por una textura horizontal rayada, obtenida mediante un innovador proceso de prensado mecánico que confiere al material un relieve tridimensional, suave al tacto. Con su geometría rigurosa y elegante, el acabado taiga es capaz de potenciar tanto los tonos claros del roble como los tonos oscuros de la madera teñida de ébano.

EN In both rovere and tinto ebano wood, the new taiga finishing is available for several products in the collection: Link+, Aura, Moon, Luxor, Self, Wind, Opus, Zenit, Cover, Modulor and Radius.

IT In entrambe le essenze, rovere e tinto ebano, la nuova finitura taiga è disponibile per diversi prodotti della collezione: Link+, Aura, Moon, Luxor, Self, Wind, Opus, Zenit, Cover, Modulor e Radius.

DE Die neue Holzaustrführung Taiga in den Hölzer Rovere und Rovere Tinto Ebano ist auf verschiedene Produkte der Kollektion erhältlich: Link+, Aura, Moon, Luxor, Self, Wind, Opus, Zenit, Cover, Modulor und Radius.

FR Dans les deux essences, teinté chêne et ébène, la nouvelle finition taiga est disponible pour différents produits de la collection : Link +, Aura, Moon, Luxor, Self, Wind, Opus, Zenit, Cover, Modulor et Radius.

ES En ambas las maderas, roble y teñido ébano, el nuevo acabado taiga es disponible para varios productos de la colección: Link+, Aura, Moon, Luxor, Self, Wind, Opus, Zenit, Cover, Modulor y Radius.

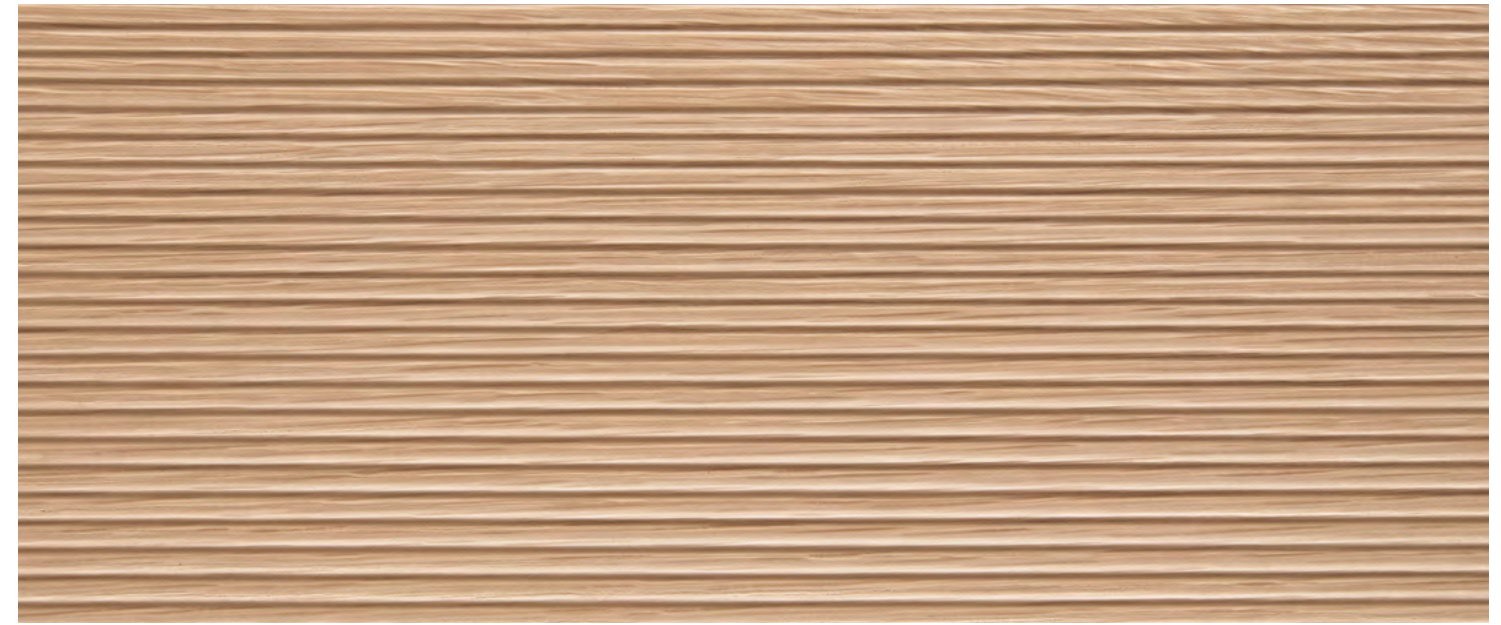

701 rovere taiga

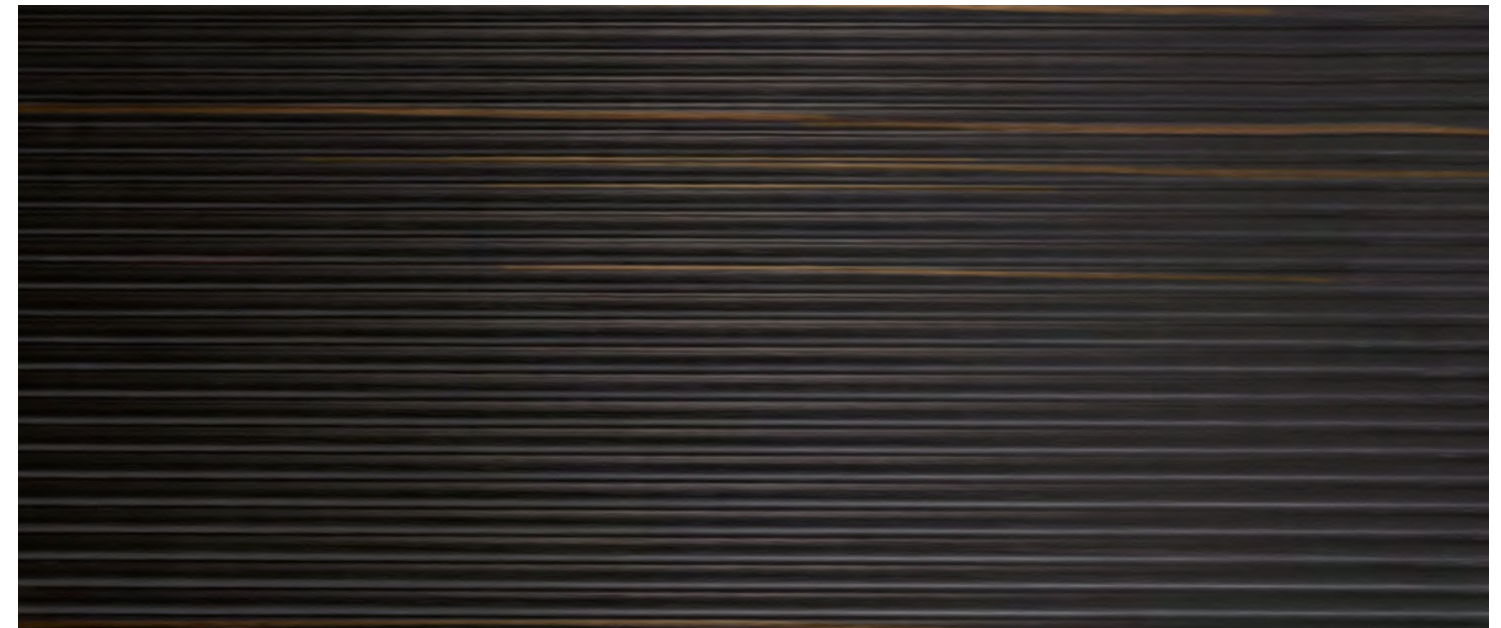

700 tinto ebano taiga

# RADIUS

EN Radius is the new bi-directional pivot door system designed by Giuseppe Bavuso. An innovative proposal in the Rimadesio's design process is the gradual elimination of structural elements, such as jambs and frames, to create solutions that can fit into environments maximising the superior qualities of an exclusive material such as aluminium. A full-height solution that is perfectly double-sided and coplanar to the wall, with a minimal design intended to blend harmoniously with the surrounding architecture.

IT Radius è il nuovo sistema di porte a bilico bidirezionale disegnato da Giuseppe Bavuso. Una proposta innovativa nel percorso progettuale Rimadesio: la progressiva eliminazione degli elementi strutturali, come stipiti e telai, per creare proposte che si possano inserire negli ambienti valorizzando al massimo le qualità superiori di un materiale esclusivo come l'alluminio. Una soluzione a tutta altezza perfettamente bifacciale e complanare alla parete, dal design minimale concepito per ricreare una perfetta continuità con l'architettura circostante.

DE Radius ist das neue bidirektionale Schwenktürsystem, von Giuseppe Bavuso entworfen. Ein innovativer Ansatz im Gestaltungsprozess von Rimadesio: die schrittweise Beseitigung von Strukturelementen wie Pfosten und Rahmen, um Angebote zu schaffen, die sich in die Räume einfügen, und gleichzeitig die überlegenen Eigenschaften eines exklusiven Materials wie Aluminium zur vollen Geltung zu bringen. Eine Lösung über die volle Höhe, perfekt beidseitig und komplanar zur Wand, mit einem minimalistischen Design, das eine perfekte Kontinuität mit der umgebenden Architektur herstellt.

FR Radius est le nouveau système de porte pivotante bidirectionnelle conçu par Giuseppe Bavuso. Une proposition innovante dans le parcours de conception de Rimadesio: l'élimination progressive des éléments structurels, tels que les jambages et les cadres, pour créer des propositions pouvant s'insérer dans les espaces, en mettant au maximum en valeur l'excellente qualité d'un matériau exclusif comme l'aluminium. Une solution toute hauteur parfaitement biface et coplanaire au mur, au design minimaliste conçu afin de recréer une continuité parfaite avec l'architecture environnante.

ES Radius es el nuevo sistema de puertas pivotantes bidireccionales diseñado por Giuseppe Bavuso. Una propuesta innovadora en la trayectoria conceptual de Rimadesio: la eliminación progresiva de elementos estructurales, como jambas y marcos, para crear propuestas que puedan integrarse en los ambientes, poniendo en valor la calidad superior de un material exclusivo como el aluminio. Una solución de suelo a techo coplanaria a la pared y válida para ambos lados, con un diseño minimalista concebido para recrear una perfecta continuidad con la arquitectura circundante.



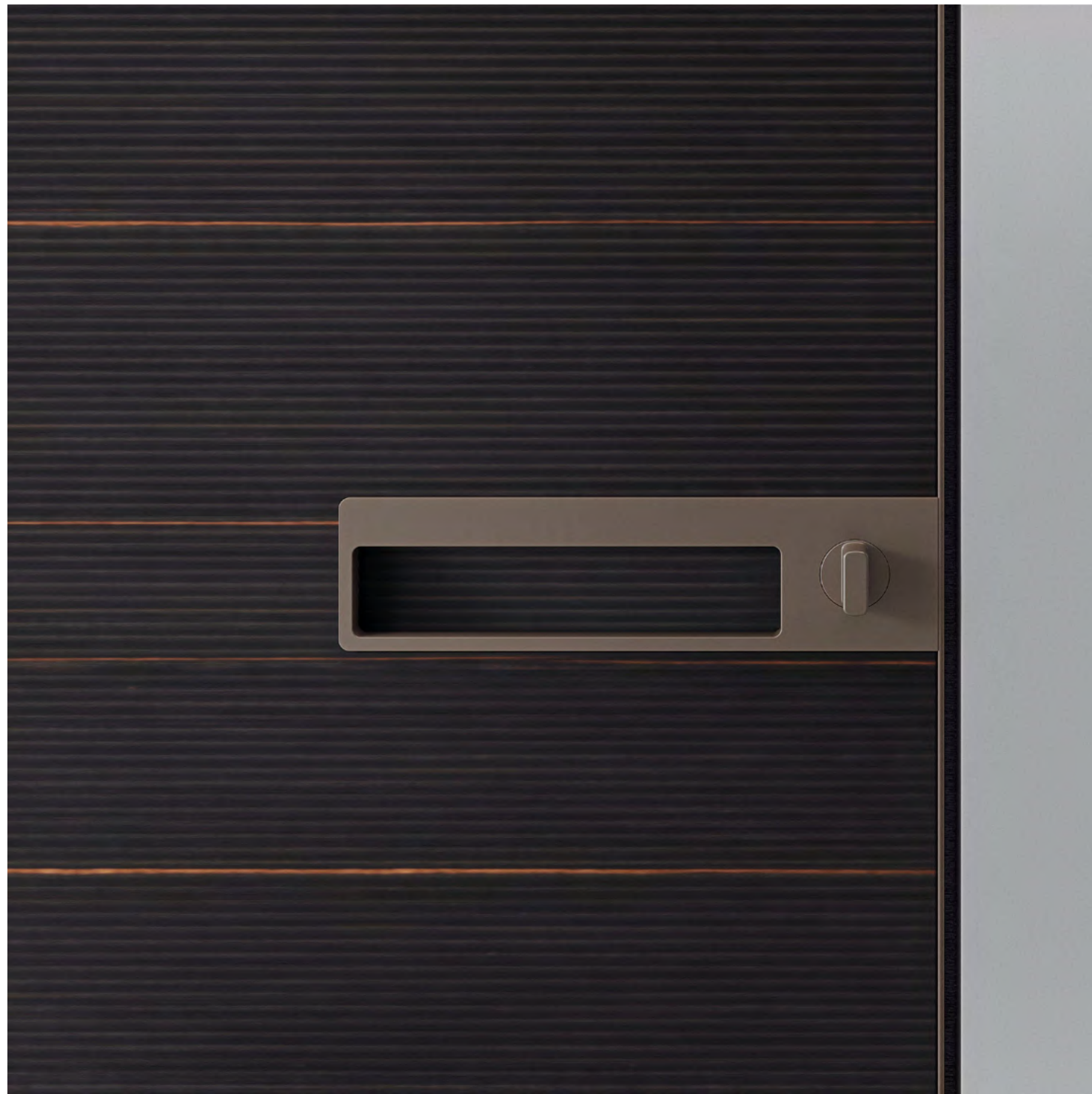



RADIUS  
porta con traversini orizzontali/  
door with horizontal crosspieces  
struttura/structure: 303 bronzo  
pannello porta/door panel: G002 moka

Porta singola  
Single door

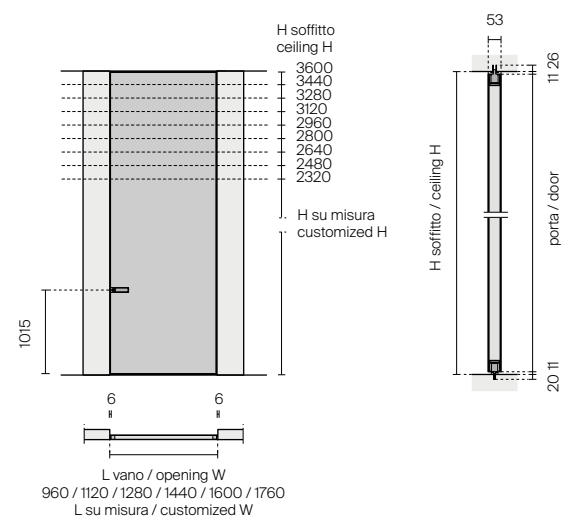

Porta doppia  
Double door

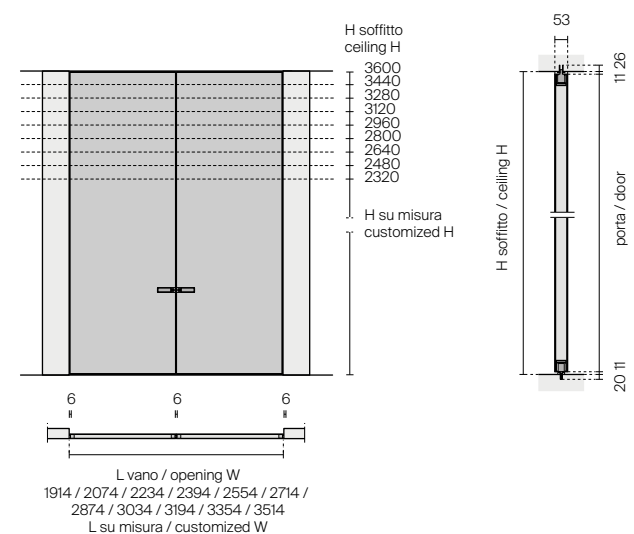

Porta bidirezionale senza stipite  
Bi-directional door without jamb

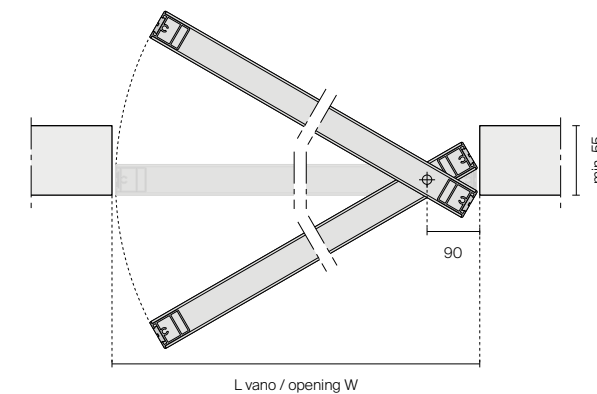
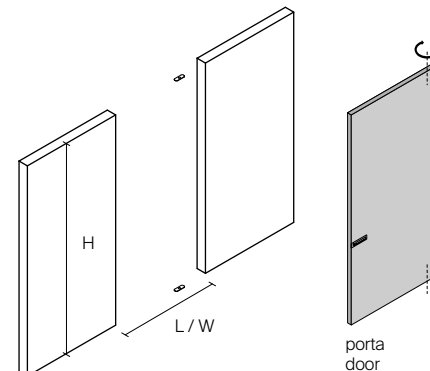

Porta bidirezionale con stipite e profilo di chiusura magnetico  
Bi-directional door with jamb and magnetic locking profile

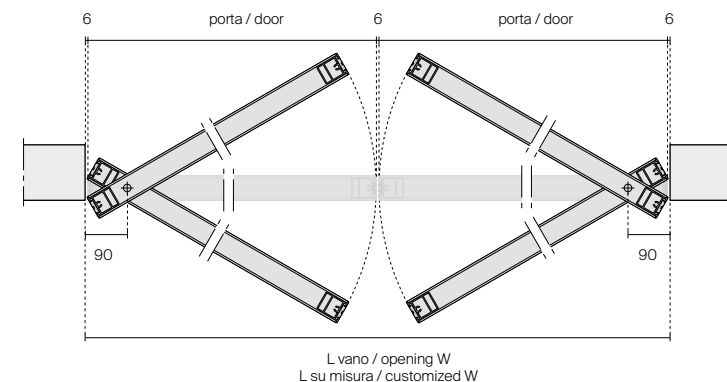
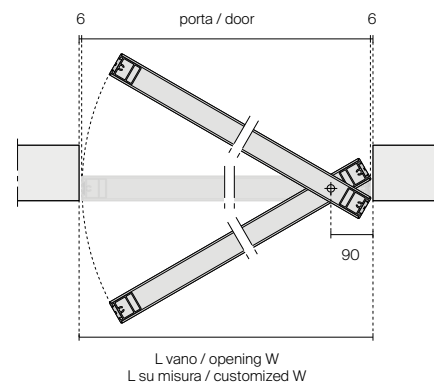
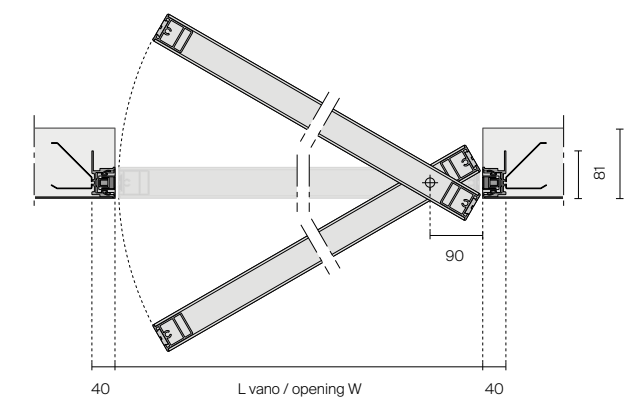
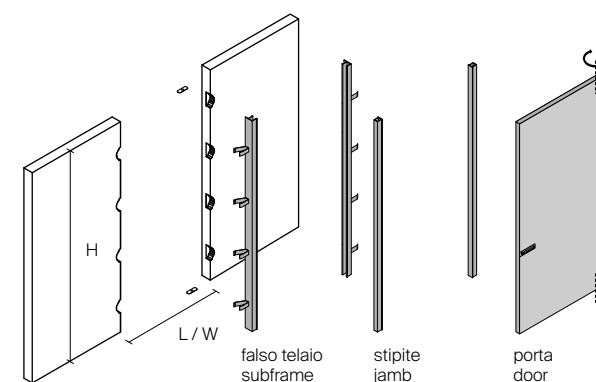

Porta bi-direzionale abbinata a boiserie modulare  
Bi-directional door combined with Modular panelling

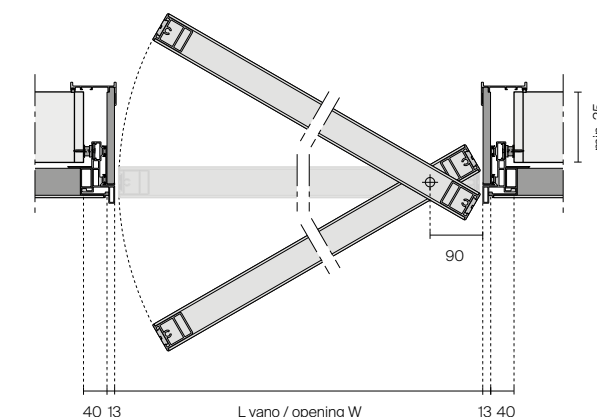
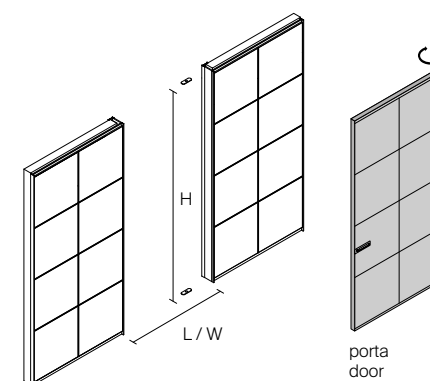

DESCRIZIONE TECNICA  
TECHNICAL DESCRIPTION

EN Always made to measure in height and width, Radius can be applied to large dimensions, with panels reaching 3600 mm in height and 1760 mm in width. It is also available in a double leaf version. The product's versatility allows installation on the wall without a jamb, with a concealed jamb equipped with a magnetic closing profile, or integrated into the Modulor boiserie system.

IT Realizzata sempre su misura in altezza e larghezza, Radius è capace di declinarsi su grandi dimensioni, con pannelli che raggiungono 3600 mm in altezza e 1760 mm in larghezza. E' disponibile anche nella versione a doppio battente. La versatilità del prodotto permette l'installazione su parete senza stipite, con stipite a scomparsa dotato di profilo di chiusura magnetico, oppure integrata nella boiserie Modulor.

DE Immer sowohl in der Breite als auch in der Höhe auf Maß gefertigt, ist Radius in der Lage den Anforderungen an große Dimensionen zu entsprechen, nämlich mit Türpaneelen die 3600 mm in der Höhe und 1760 mm in der Breite erreichen können. Radius ist auch als Doppelflügeltür erhältlich. Die Vielseitigkeit des Produktes erlaubt die wandbündige Montage, die Verwendung von unsichtbaren seitlichen Profilen mit Schließmechanismus oder die Einbindung in das Wandverkleidungssystem Modulor.

FR Toujours sur mesure en hauteur et en largeur, Radius est capable de se décliner sur de grandes dimensions, avec des panneaux qui atteignent 3600 mm de hauteur et 1760 mm de largeur. Elle est également disponible dans la version à double vantaux. La versatilité du produit permet soit une installation contre le mur sans jambage, soit avec un jambage doté d'un profil de fermeture magnétique, soit d'être intégrée dans la boiserie Modulor.

ES Siempre a medida en altura y anchura, Radius es capaz de declinar en grandes dimensiones, con paneles que alcanzan los 3600 mm de altura y los 1760 mm de anchura. También está disponible en la versión doble pivotante. La versatilidad del producto permite la instalación sobre pared sin jamba, con jamba embutida con perfil de cierre magnético, o integrada en la boiserie Modulor.

Senza traversini  
Without crosspieces

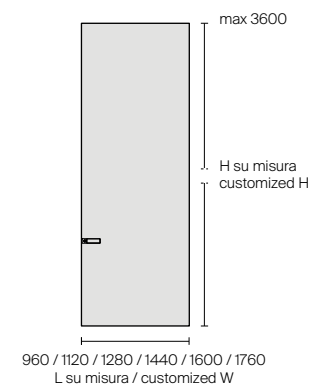

Con traversini orizzontali  
With horizontal crosspieces

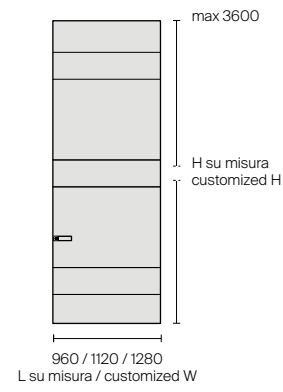
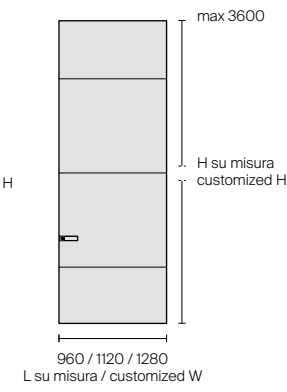

Con traversini orizzontali e verticali  
With horizontal and vertical crosspieces

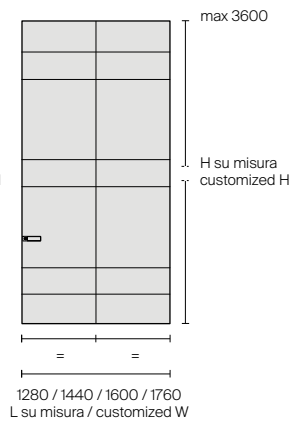
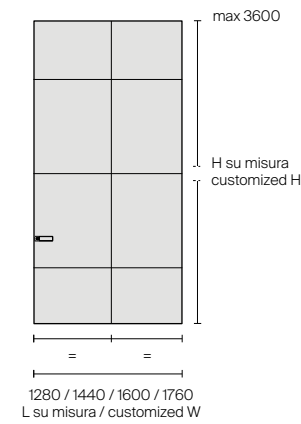

EN The panel is available with full-length mirror or with decorative horizontal and vertical crosspieces. The aluminium frame of Radius is available in aluminium, brown and 46 Ecoloursystem finishings. The double-sided door panel cladding is available in glossy, mat, reflex, sahara, diamante and mirror lacquered glass or in Litech, sahara and taiga essence, fabric or synthetic leather, for a total of 161 finishings.

IT Il pannello è disponibile a specchiatura intera o con traversi decorativi orizzontali e verticali. La struttura in alluminio di Radius è disponibile in finitura alluminio, brown e nelle 46 varianti ecoloursystem. Il rivestimento bifacciale del pannello porta è disponibile in vetro laccato lucido, opaco, reflex, sahara, diamante, specchio oppure in Litech, in essenza sahara e taiga, in tessuto o similpelle, per un totale di 161 finiture.

DE Das Türblatt ist komplett verspiegelt oder mit horizontalen bzw. vertikalen Dekorstreben erhältlich. Die Aluminiumstruktur der Tür ist in den Oberflächen Aluminium, Brown sowie allen 46 Ecoloursystem-Farben verfügbar. Die beidseitigen Füllungen des Türblattes sind in Glas glänzend und matt, Gläsern Reflex, Sahara, Diamante, Spiegel, sowie Holz furnier Sahara, Taiga und Stoff oder Kunstleder erhältlich. Somit ist Radius in insgesamt 161 verschiedenen Ausführungen erhältlich.

FR Le panneau est disponible avec verre plein ou avec des traverses décoratives horizontales ou verticales. La structure en aluminium de Radius est disponible en finition aluminium, brown, et dans les 46 variantes ecoloursystem. Le revêtement double face du panneau de la porte est disponible en verre laqué brillant, opaque, reflex, sahara, diamante, miroir ou en Litech, essence sahara et taiga, en tissu ou simili cuir, avec un total de 161 finitions.

ES El panel está disponible sin divisiones o con travesaños decorativos horizontales y verticales. La estructura en aluminio de Radius está disponible en acabado aluminio, brown y en las 46 variantes ecoloursystem. El revestimiento de doble cara del panel puerta está disponible en cristal lacado brillante, mate, reflex, sahara, diamante, espejo o en Litech, en madera sahara y taiga, en tejido o simil cuero, para un total de 161 acabados.

Struttura e maniglia  
Structure and handle

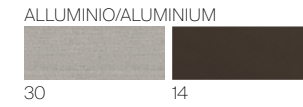
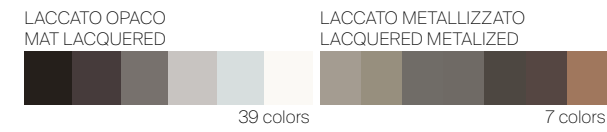

Pannello porta  
Door panel

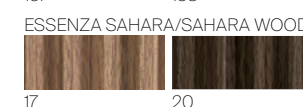
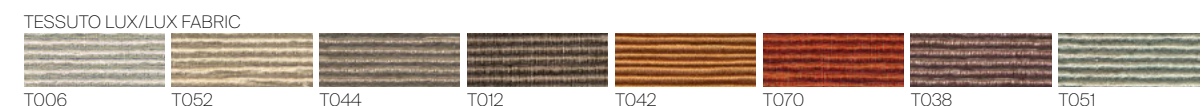
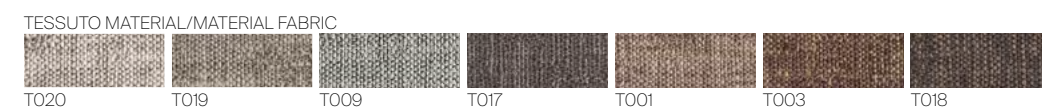
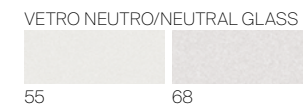
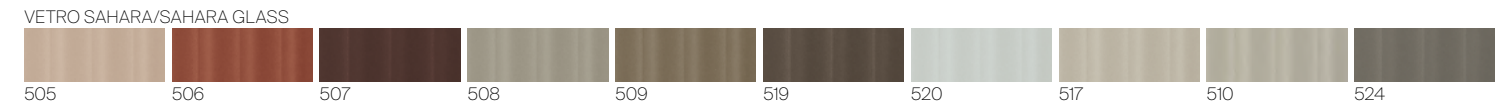
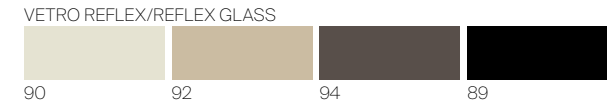
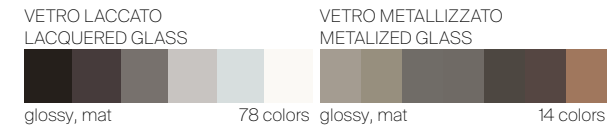



## SELF

EN New aesthetics and new solutions for Self, the sideboard system that is now a classic in the Rimadesio collection. The protagonist of the new compositions is the unprecedented taiga finishing proposed in two different essences: rovere and tinto ebano. The surface is marked by a finely striped horizontal texture, obtained by a mechanical pressing process that gives the material a three-dimensional relief, soft to the touch.

IT Nuova estetica e nuove soluzioni per Self, il sistema di madie che rappresenta ormai un classico della collezione Rimadesio. Protagonista delle nuove composizioni l'inedita finitura taiga proposta in due diverse essenze: rovere e tinto ebano. La superficie è scandita da una texture orizzontale finemente rigata, ottenuta con un processo di pressatura meccanica che dona alla materia un rilievo tridimensionale, morbido al tatto.

DE Neue Ästhetik und neue Lösungen für Self, das Sideboard-System, ein Klassiker der Rimadesio-Kollektion. Hauptprodukt der neuen Kompositionen ist das neue Taiga-Finish, das in zwei verschiedenen Essenzen angeboten wird: Rovere und Tinto Ebano. Die Oberfläche zeichnet sich durch eine fein gestreifte horizontale Textur aus, die durch einen mechanischen Pressvorgang erhalten wird, der dem Material ein dreidimensionales Relief verleiht, das sich weich anfühlt.

FR Nouvelle esthétique et nouvelles solutions pour Self, le système de bahuts représentatif de la collection Rimadesio. Le protagoniste des nouvelles compositions est la nouvelle finition taïga proposée en deux essences différentes: rovere et ebano. La surface est marquée par une texture horizontale finement rayée, obtenue par un procédé de pressage mécanique qui donne au matériau un relief tridimensionnel, doux au toucher.

ES Nueva estética y nuevas soluciones para Self, el sistema de aparadores que representa un clásico de la colección Rimadesio. El protagonista de las nuevas composiciones es el inédito acabado taiga propuesto en dos maderas diferentes: rovere y ebano. La superficie está marcada por una textura horizontal finamente rayada, obtenida mediante un proceso de prensado mecánico que confiere al material un relieve tridimensional, suave al tacto.



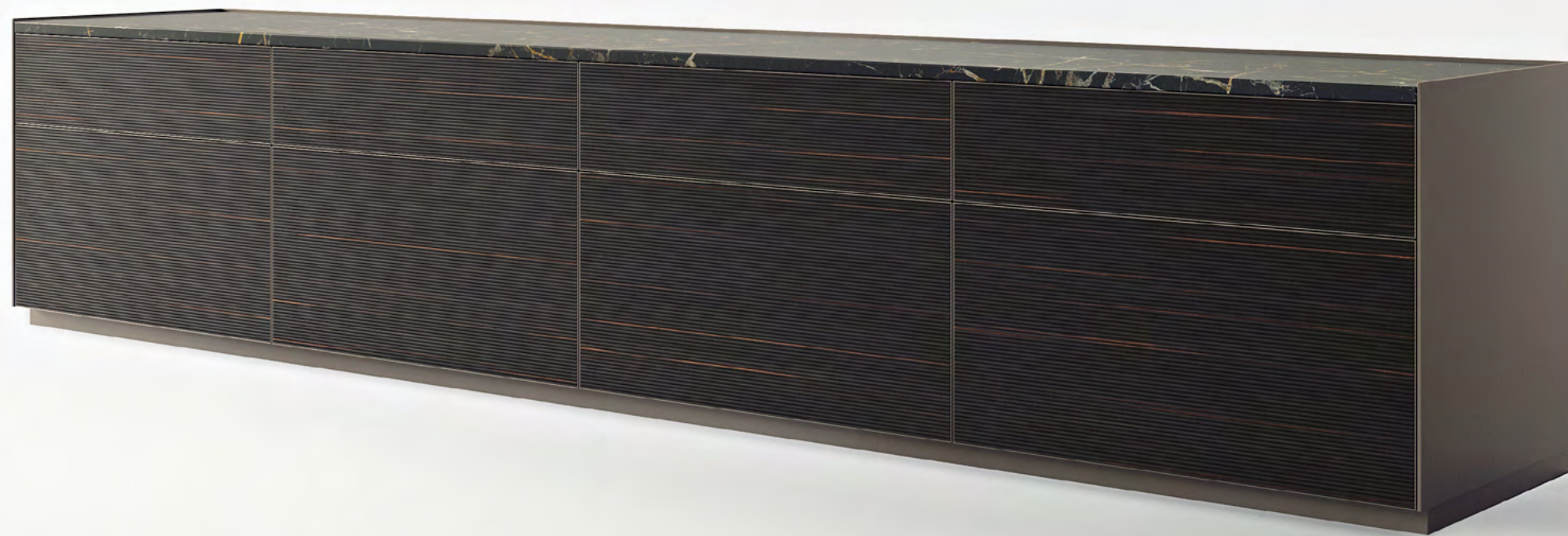

SELF  
struttura/structure: 303 bronzo  
frontali/fronts: 700 tinto ebano taiga  
top in marmo/marble top: 183 noir saint laurent



SELF  
struttura/structure: 303 bronzo  
frontali/fronts: 700 tinto ebano taiga  
top in marmo/marble top: 183 noir saint laurent

# ZENIT BOOKCASE

EN In the bookcase version, Zenit has even greater design potential with the introduction of a brand new backlighted upright and a new suspended containers which, like all Zenit compositional elements, allow for free positioning. The range includes a chest of drawers, a container with doors, a chest of drawers with a flap door and drawer and a container with a flap door. The new aluminum drawers, with fully extractable runners, are equipped with an unprecedented push opening system and cushioned return.

IT Nella versione libreria Zenit amplia le proprie potenzialità progettuali con l'introduzione di un inedito montante retroilluminato e di nuovi contenitori sospesi che, come tutti gli elementi compositivi di Zenit, consentono un libero posizionamento. La gamma comprende: cassetiera, contenitore con ante, cassetiera con anta ribalta e cassetto, contenitore con anta ribalta. I nuovi cassetti in alluminio, con guide ad estrazione totale, sono dotati di un inedito sistema di apertura push e rientro ammortizzato.

DE In der Bücherregal-version erweitert Zenit sein Gestaltungspotential mit der Einführung eines brandneuen hinterleuchteten Pfosten und neuer hängender Zubehöre, die wie alle Zenit-Kompositionselemente eine freie Positionierung ermöglichen. Das Sortiment umfasst Elemente mit Schublade, Drehtüren, Klappen oder auch Elemente mit Klapptüre und Schublade sowie ein mit Klapptüre. Die neuen Aluminiumschubladen mit Vollauszügen sind mit einem PushÖffnungs-system und Amortisations-rücklauf ausgestattet.

FR Dans la version bibliothèque, Zenit élargit son potentiel de conception avec l'introduction d'un tout nouveau montant rétro-éclairé et de nouveaux conteneurs suspendus qui, comme tous les éléments de composition Zenit, permettent un positionnement libre. La gamme comprend : bloc tiroirs, conteneur avec portes, bloc tiroir avec porte abattante et tiroir, conteneur avec porte abattante. Les nouveaux tiroirs en aluminium, avec glissières entièrement extractibles, sont équipés d'un système d'ouverture en poussant avec retour amorti.

ES En la versión librería, Zenit amplía su potencial de diseño con la introducción de un nuevo montante retroiluminado y de nuevos contenedores colgantes que, como todos los elementos compositivos de Zenit, permiten un posicionamiento libre. La gama incluye: cajonera, contenedor con puertas, contenedor con puerta abatible y cajonera, contenedor con puerta abatible. Los nuevos cajones en aluminio, con guías completamente extraíbles, están equipados con un inedito sistema de apertura push y retorno amortizado.

Contenitore con cassetti  
Suspended unit with drawers



Contenitore con ante battenti  
Suspended unit with hinged doors



Contenitore con un cassetto e un'anta a ribalta  
Suspended unit with drawer and flap door



Contenitore con cassetto  
Suspended unit with drawer



Zenit libreria  
Zenit bookcase

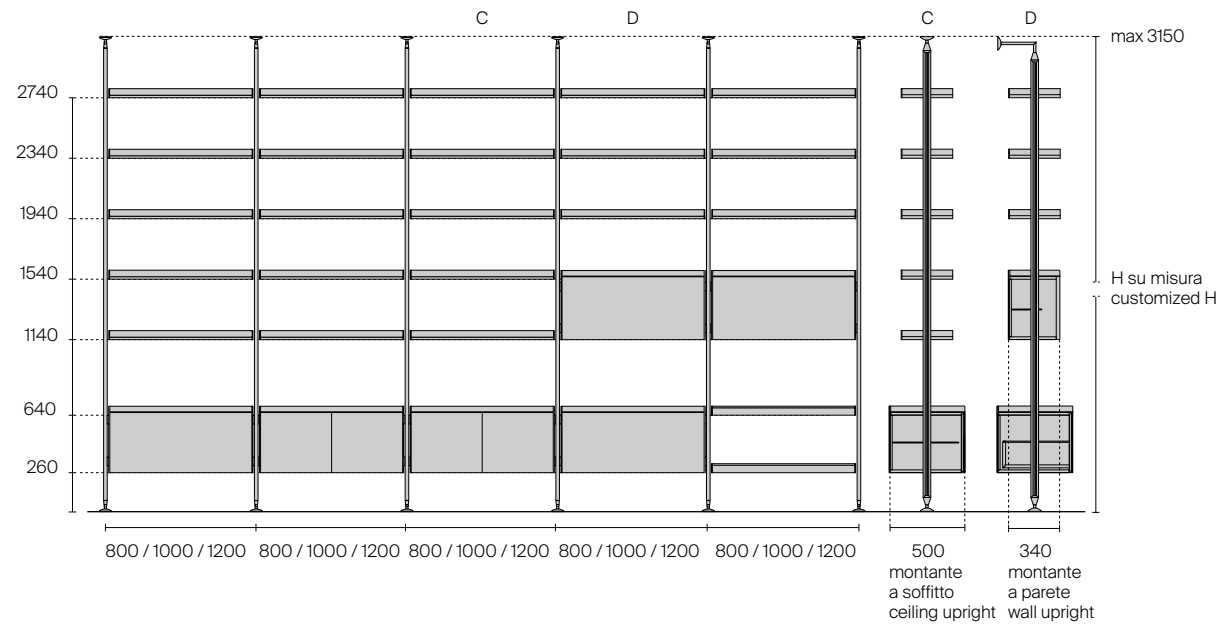
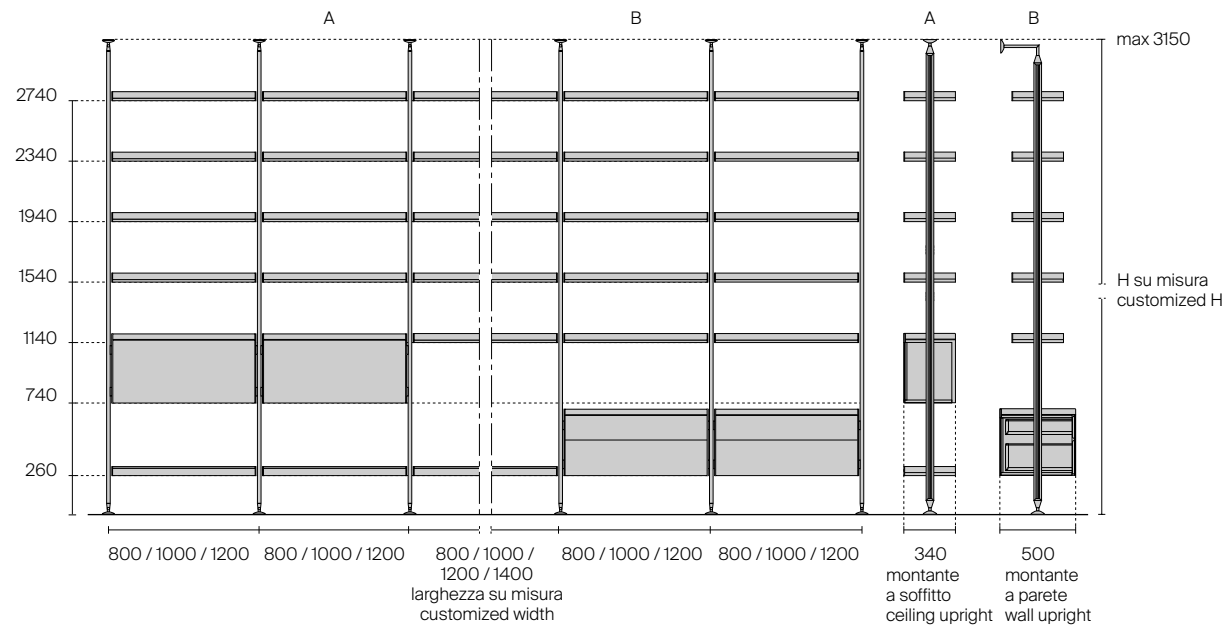

MONTANTI  
UPRIGHTS

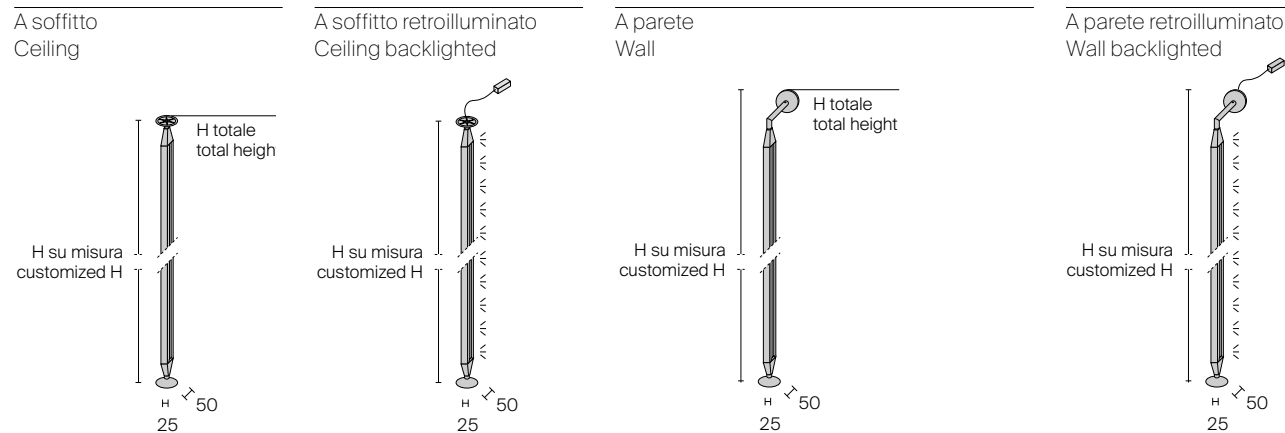

COMPONENTI  
COMPONENTS

Contenitore con cassetti P 500  
Suspended unit with drawers D 500

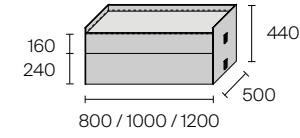

Contenitore con un cassetto e un'anta a ribalta P 500  
Suspended unit with drawer and flap door D 500

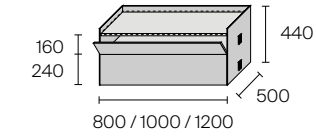

Contenitore con cassetto P 500  
Suspended unit with drawer D 500

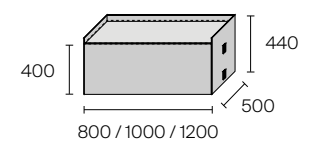

Contenitore con ante battenti P 500  
Suspended unit with hinged doors D 500

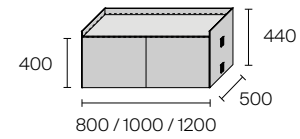

Contenitore con anta a ribalta P 340  
Suspended unit with flap door D 340  
fianco alto/high side

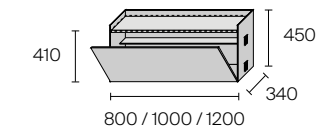

Contenitore con anta a ribalta P 340  
Suspended unit with flap door D 340  
fianco basso/low side

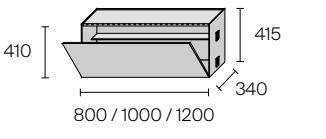

Top di finitura in vetro spessore 4mm  
Finishing top in glass thickness 4mm

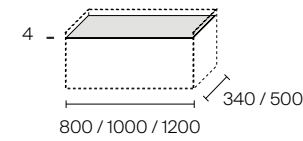

Top di finitura in Litech spessore 4mm  
Finishing top in Litech thickness 4mm

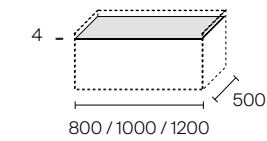

Top di finitura in marmo spessore 20mm  
Finishing top in marble thickness 20mm

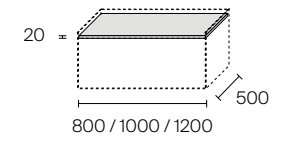

Ripiano in vetro opzionale  
Optional glass shelf  
Disponibile per contenitore con ante battenti  
Available for container with hinged doors

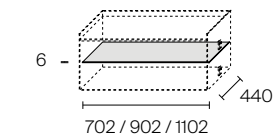

Mensola in vetro rivestita in similpelle  
Glass shelf covered with synthetic leather

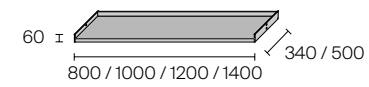

Passacavo opzionale per contenitori profondità 500  
Optional cable duct for units depth 500

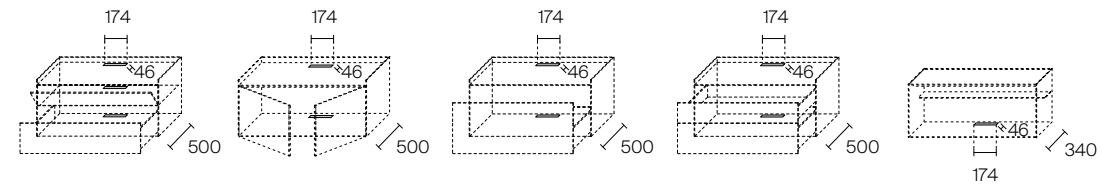

non disponibile per contenitori con top in marmo / not available for units with marble top

Passacavo interno opzionale per contenitori profondità 340  
Optional internal cable duct for units depth 340

Illuminazione interna opzionale per contenitori  
Optional internal lighting

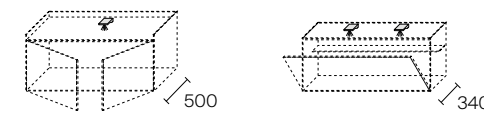

Alimentatore elettronico per presa comandata o per sistema Dali o per telecomando  
Electronic control gear for power switch or Dali system control gear or electronic control gear for remote control device

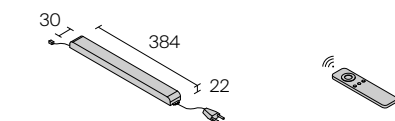

# ZENIT WALK-IN CLOSET

EN The Zenit walk-in closet increases its design potential with the introduction of new freely positionable suspended drawer units. The drawers are internally lined with fabric or synthetic leather and they are available in two heights and four aesthetic versions: open drawer without front, drawer with glass front, drawer with synthetic leather front, drawer with lacquered front. Also for the walk-in closet version, the new backlighted upright is available.

IT La cabina armadio Zenit amplia le proprie potenzialità progettuali con l'introduzione di nuove cassettiere sospese liberamente posizionabili. I cassetti sono rivestiti internamente in tessuto o similpelle e sono disponibili in due altezze e in quattro versioni estetiche: cassetto aperto senza frontale, cassetto con frontale in vetro, cassetto con frontale in similpelle, cassetto con frontale laccato. Anche per la versione cabina armadio, è previsto il nuovo montante retroilluminato.

DE Der begehbare Kleiderschrank Zenit erweitert sein Gestaltungspotential durch die Einführung neuer, frei positionierbarer Hängeschubladenblöcke. Die Schubladen sind innen mit Stoff oder Kunstleder bezogen und in zwei Höhen sowie in vier ästhetischen Ausführungen erhältlich: offene Schublade ohne Front, Schublade mit Glasfront, Schublade mit Kunstlederfront, Schublade mit lackierter Front. Eine weitere Neuheit sind die mit Kunstleder bezogenen Glasböden, die in 7 Farben erhältlich sind. Der neue hinterleuchtete Pfosten ist auch für die Zenit Schrankversion erhältlich.

FR Le dressing Zenit élargit son potentiel de conception avec l'introduction de nouveaux blocs-tiroirs suspendus librement positionnables. Les tiroirs sont recouverts à l'intérieur de tissu ou de similicuir et sont disponibles en deux hauteurs et en quatre versions esthétiques: tiroir ouvert sans façade, tiroir avec façade en verre, tiroir avec façade en similicuir, tiroir avec façade laquée. Autre nouveauté, les étagères en verre recouvertes de similicuir, disponibles en 7 couleurs. Le nouveau montant rétro-éclairé est également disponible pour la version dressing.

ES El vestidor Zenit amplía su potencial de diseño con la introducción de nuevas cajoneras colgantes de libre posicionamiento. Los cajones están revestidos interiormente en tejido o simil cuero y están disponibles en dos alturas y en cuatro versiones estéticas: cajón abierto sin frente, cajón con frente en cristal, cajón con frente de simil cuero, cajón con frente lacado. Otra novedad son los estantes de cristal revestidos en simil cuero, disponibles en 7 colores. El nuevo montante retroiluminado también está disponible para la versión vestidor.





ZENIT  
struttura/structure: 303 bronzo  
rivestimento interno in similpelle/synthetic leather  
internal cladding: 157 arena  
top e frontale in vetro/top and glass front: 63 grigio  
trasparente

Zenit cabina armadio  
Zenit walk-in closet

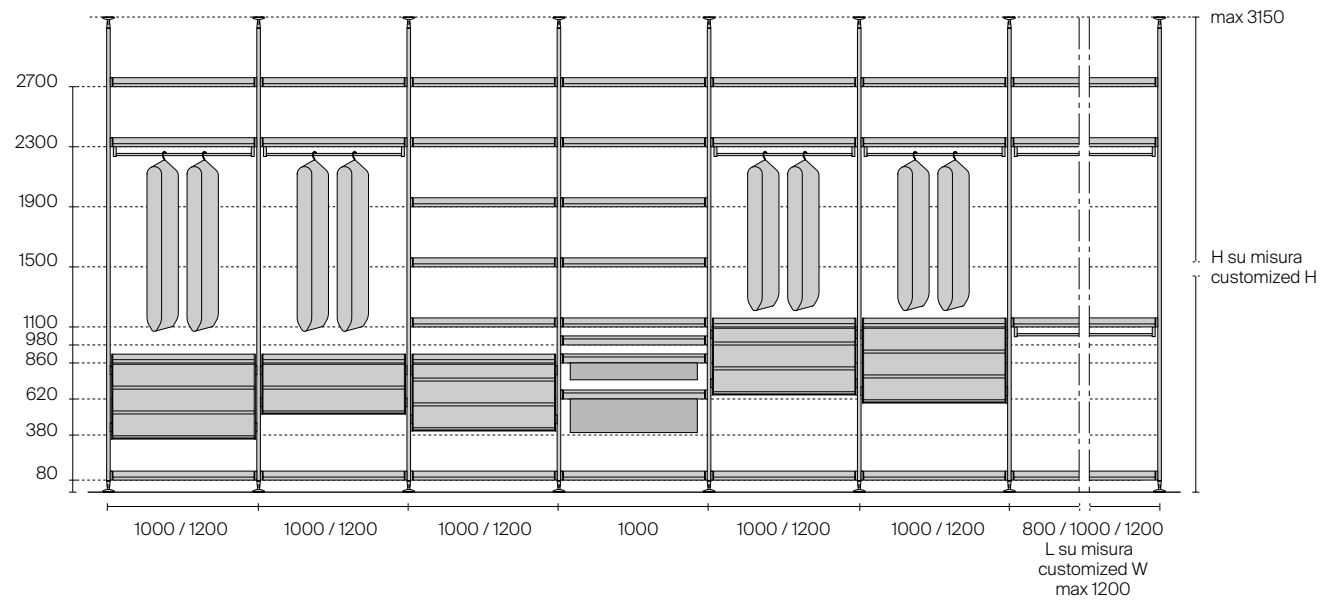

MONTANTI  
UPRIGHTS

A soffitto Ceiling  
A soffitto retroilluminato Ceiling backlighted  
A parete Wall  
A parete retroilluminato Wall backlighted

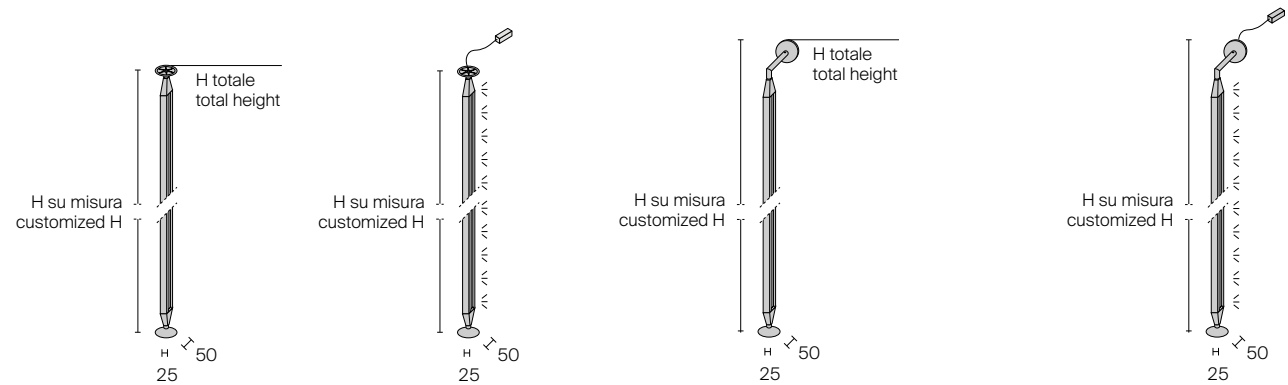

COMPONENTI  
COMPONENTS

Alimentatore elettronico per presa comandata o per sistema Dali o per telecomando  
Electronic control gear for power switch or Dali system control gear or electronic control gear for remote control device

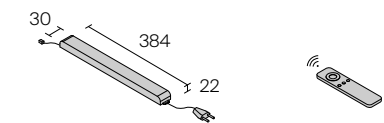

Mensola rivestita in similpelle  
Shelf covered with synthetic leather

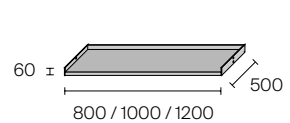

Mensola angolare rivestita in similpelle  
Corner shelf covered with synthetic leather

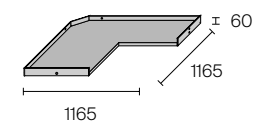

Mensola portascarpe rivestita in similpelle  
Shoe shelf covered with synthetic leather

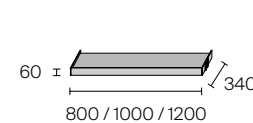

H 400 CON DUE CASSETTI/WITH TWO DRAWERS

2 frontali laccati  
2 lacquered fronts

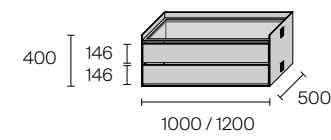

2 frontali vetro  
2 glass fronts

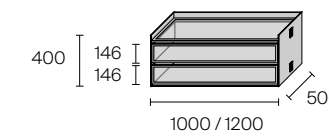

2 frontali similpelle  
2 synthetic leather fronts

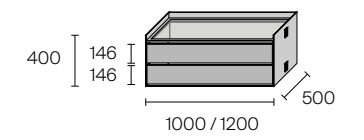

1 frontale vetro, 1 frontale laccato  
1 glass front, 1 lacquered front

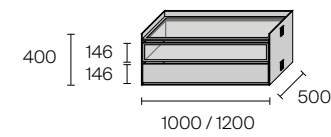

1 frontale vetro, 1 cassetto aperto senza frontale  
1 glass front, 1 open drawer without front

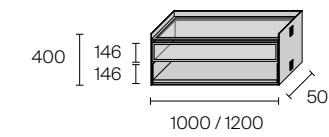

2 cassetti aperti senza frontale  
2 open drawers without front

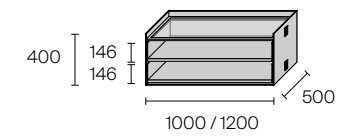

H 515 CON TRE CASSETTI/WITH THREE DRAWERS

3 frontali laccati  
3 lacquered fronts

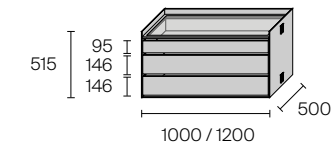

3 frontali vetro  
3 glass fronts

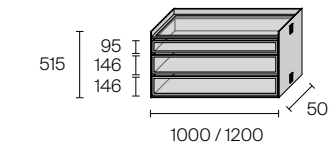

3 frontali similpelle  
3 synthetic leather fronts

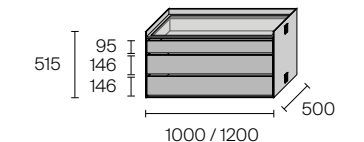

1 frontale vetro, 2 frontali laccati  
1 glass front, 2 with lacquered fronts

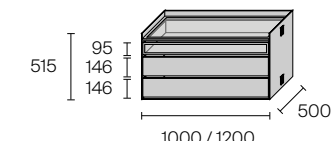

1 frontale vetro, 2 cassetti aperti senza frontale  
1 glass front, 2 open drawers without front

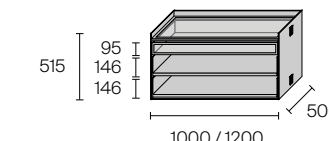

H 566 CON TRE CASSETTI/WITH THREE DRAWERS

3 frontali laccati  
3 lacquered fronts

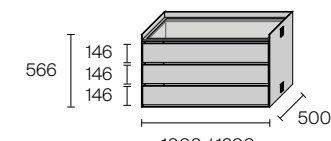

3 frontali vetro  
3 glass fronts

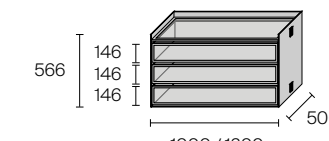

3 frontali similpelle  
3 synthetic leather fronts

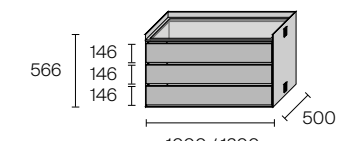

1 frontale vetro, 2 frontali laccati  
1 glass front, 2 with lacquered fronts

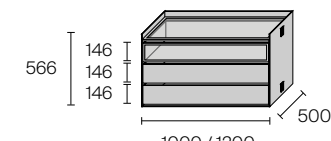

1 frontale vetro, 2 cassetti aperti senza frontale  
1 glass front, 2 open drawers without front

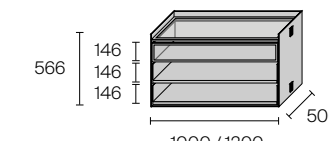

3 cassetti aperti senza frontale  
3 open drawers without front

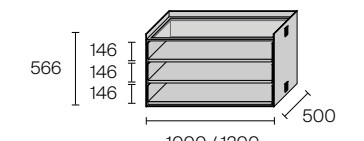

## COVER

EN The Cover project expands its design potential with the introduction of new suspended drawer units. The drawers are internally lined with fabric in 15 colour variants or synthetic leather in 7 colour variants and they are available in two heights and four aesthetic versions: open drawer without front, drawer with glass front, drawer with synthetic leather front, drawer with lacquered front.

IT Il progetto Cover amplia le proprie potenzialità progettuali con l'introduzione di nuove cassettiere sospese. I cassetti sono rivestiti internamente in tessuto in 15 varianti di colore o in similpelle in 7 varianti di colore e sono disponibili in due altezze e in quattro versioni estetiche: cassetto aperto senza frontale, cassetto con frontale in vetro, cassetto con frontale in similpelle, cassetto con frontale laccato.

DE Das Cover-Projekt erweitert sein Gestaltungspotential mit der Einführung neuer hängender Schubladenelemente, die in einer Breite von 1096 mm erhältlich sind. Die Schubladen sind innen mit Stoff (15 Farbvarianten) oder Kunstleder (7 Farbvarianten) bezogen und in zwei Höhen sowie in vier ästhetischen Ausführungen erhältlich: offene Schublade ohne Front, Schublade mit Glasfront, Schublade mit Kunstlederfront, Schublade mit lackierter Front.

FR Le projet Cover élargit son potentiel de conception avec l'introduction de nouveaux blocs-tiroirs suspendus. Les tiroirs sont recouverts à l'intérieur de tissu, avec 15 coloris différents, ou de similicuir, avec 7 déclinaisons de couleurs, et ils sont disponibles en deux hauteurs et en quatre versions esthétiques : tiroir ouvert sans façade, tiroir avec façade en verre, tiroir avec façade en similicuir, tiroir avec façade laquée.

ES El proyecto Cover amplía su potencial de diseño con la introducción de nuevas cajoneras colgantes. Los cajones están forrados internamente con tejido en 15 variantes de color o similar cuero en 7 variantes de color y están disponibles en dos alturas y en cuatro versiones estéticas: bandeja sin frente, cajón con frente de cristal, cajón con frente de similar cuero, cajón con frente lacado.

TIPOLOGIE ESTETICHE CASSETTIERE SOSPESA  
SUSPENDED DRAWER UNITS AESTHETICAL TYPOLOGIES

Top in vetro trasparente, 1 cassetto con frontale in vetro, 2 cassetti aperti senza frontale. Rivestimento interno cassetti in tessuto.  
Transparent glass top, 1 drawer with glass front, 2 open drawers without front. Fabric internal drawer cladding.



Top in vetro trasparente, 3 cassetti con frontale in vetro. Rivestimento interno cassetti in similpelle.  
Transparent glass top, 3 drawers with glass front. Synthetic leather internal drawer cladding.



Top in vetro trasparente, 1 cassetto con frontale in vetro, 2 cassetti con frontale laccato. Rivestimento interno cassetti in similpelle.  
Transparent glass top, 1 drawer with glass front, 2 drawers with laquered fronts. Synthetic leather internal drawer cladding.



Top in similpelle, 3 cassetti con frontale in similpelle. Rivestimento interno cassetti in similpelle.  
Synthetic leather top, 3 drawers with synthetic leather fronts. Synthetic leather internal drawer cladding.



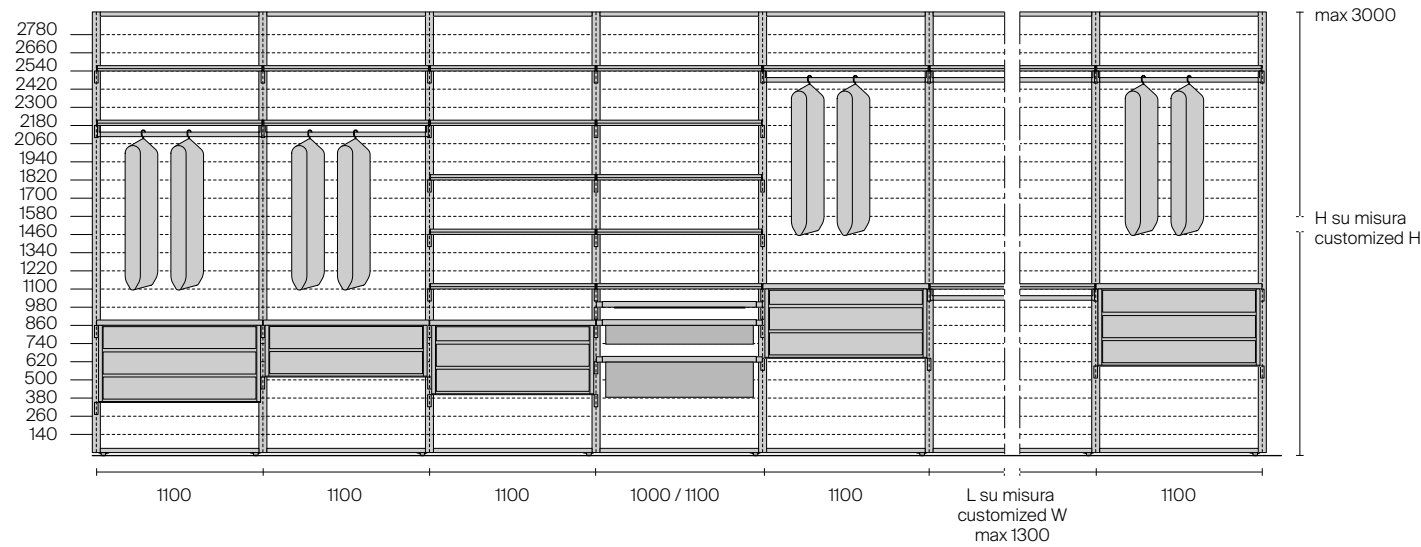

DESCRIZIONE TECNICA  
TECHNICAL DESCRIPTION

EN The Cover project is updated with a programme of modular and sectional drawer units, manufactured using the latest production technologies for processing extruded aluminium: the drawers are characterised by a thin thickness of only 8 mm and the exclusive 'folding' processing without joints on the edges.

IT Il progetto Cover si aggiorna con un programma di cassettiere modulari e componibili, realizzate con le più recenti tecnologie produttive per la lavorazione dell'alluminio estruso: i cassetti sono caratterizzati dallo spessore sottile di soli 8 mm e dall'esclusiva lavorazione "folding" senza giunzioni sugli spigoli.

DE Das Cover-Projekt wird mit einem Programm von Schubladenelementen aktualisiert, die mit den neuesten Produktions-technologien für die Verarbeitung von stranggepresstem Aluminium hergestellt sind: Die Schubladen zeichnen sich durch eine geringe Dicke von nur 8 mm und die exklusive „Folding“-Verarbeitung ohne Fugen an den Kanten aus.

FR Le projet Cover est renouvelé avec un programme de meubles tiroirs modulables, réalisés avec les technologies de production les plus récentes pour le traitement de l'aluminium extrudé: les tiroirs se caractérisent par une épaisseur fine de seulement 8 mm et le travail de "pliage" sans joints sur le bords.

ES El proyecto Cover se actualiza con un programa de cajoneras modulares y componibles, realizadas con las últimas tecnologías productivas para la elaboración del aluminio extruido: los cajones se caracterizan por un fino espesor de solo 8 mm y el exclusivo proceso "folding" sin juntas en los bordes.

H 378 CON DUE CASSETTI/WITH TWO DRAWERS

2 frontali laccati  
2 lacquered fronts

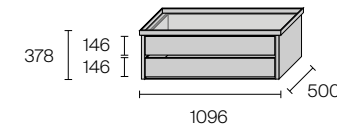

2 frontali vetro  
2 glass fronts

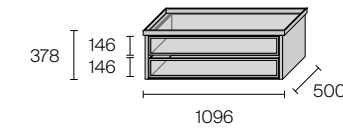

2 frontali similpelle  
2 synthetic leather fronts

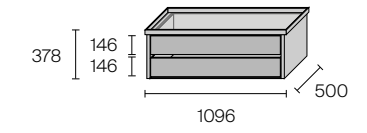

1 frontale vetro, 1 frontale laccato  
1 glass front, 1 lacquered front

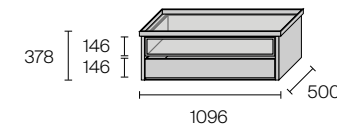

1 frontale vetro, 1 cassetto aperto senza frontale  
1 glass front, 1 open drawer without front

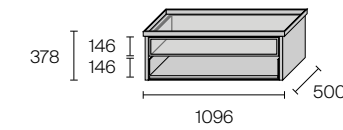

2 cassetti aperti senza frontale  
2 open drawers without front

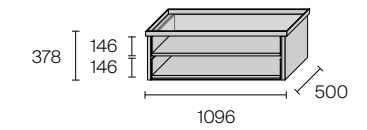

H 493 CON TRE CASSETTI/WITH THREE DRAWERS

3 frontali laccati  
3 lacquered fronts

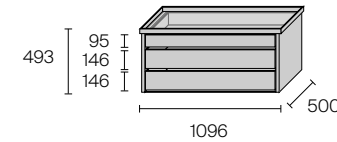

3 frontali vetro  
3 glass fronts

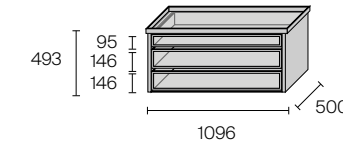

3 frontali similpelle  
3 synthetic leather fronts

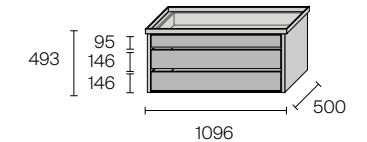

1 frontale vetro, 2 frontali laccati  
1 glass front, 2 with lacquered fronts

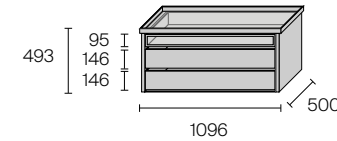

1 frontale vetro, 2 cassetti aperti senza frontale  
1 glass front, 2 open drawers without front

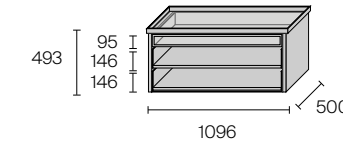

H 544 CON TRE CASSETTI/WITH THREE DRAWERS

3 frontali laccati  
3 lacquered fronts

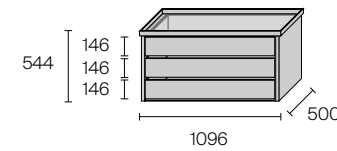

3 frontali vetro  
3 glass fronts

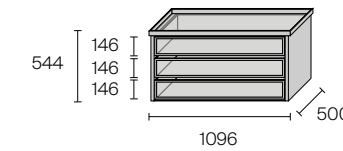

3 frontali similpelle  
3 synthetic leather fronts

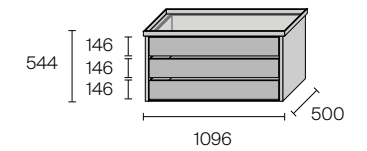

1 frontale vetro, 2 frontali laccati  
1 glass front, 2 with lacquered fronts

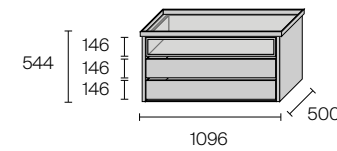

1 frontale vetro, 2 cassetti aperti senza frontale  
1 glass front, 2 open drawers without front

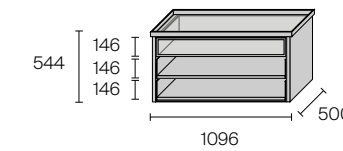

3 cassetti aperti senza frontale  
3 open drawers without front

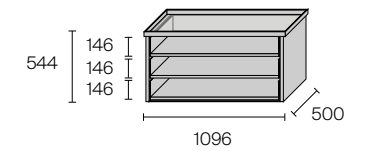

# ALIANTE

EN Aliante appears as a precious transparent glass cabinet with an original opening system. It is a cabinet with rigorous proportions, which concentrates a series of exclusive technical solutions. These include the special opening of the doors which, with a thin aluminium structure and a special glass assembly technique, exclude the presence of lateral flanks and give the container an extraordinary light and transparent image.

IT Aliante si presenta come uno scrigno prezioso in vetro trasparente, dotato di un inedito sistema di apertura. Un contenitore dalle proporzioni rigorose, che concentra una serie di soluzioni tecniche esclusive. Come la particolare apertura delle ante che, dotate di una sottile struttura in alluminio e di una speciale tecnica di assemblaggio del vetro, escludono la presenza di fianchi laterali e conferiscono al contenitore un'immagine straordinariamente leggera e trasparente.

DE Aliante sieht aus wie eine kostbare transparente Glasschatulle, die mit einem beispiellosen Öffnungssystem ausgestattet ist. Ein Behälter mit rigorosen Proportionen, der eine Reihe exklusiver technischer Lösungen konzentriert. Wie die besondere Öffnung der Türen, die, ausgestattet mit einer dünnen Aluminiumstruktur und einer speziellen Glasmontagetechnik, das Vorhandensein von Seitenwänden ausschließt und dem Container ein außergewöhnlich leichtes und transparentes Aussehen verleiht.

FR Aliante se présente comme un écrin précieux en verre transparent, doté d'un système d'ouverture inédit. Un caisson aux proportions rigoureuse qui concentre une série de solutions techniques exclusives. Comme l'ouverture particulière des vantaux, dotés d'une fine structure en aluminium et d'une technique d'assemblage spéciale du verre, excluent la présence des côtés et apportent au caisson une image extraordinairement légère et transparente.

ES Aliante tiene el aspecto de un precioso cofre de cristal transparente, equipado con un sistema de apertura inédito. Un contenedor de proporciones rigurosas, que concentra una serie de soluciones técnicas exclusivas. Como la especial apertura de las puertas, dotadas de una fina estructura de aluminio y de una técnica especial de montaje del cristal, que excluye la presencia de paneles laterales y confiere al contenedor una imagen extraordinariamente ligera y transparente.



ALIANTE  
 struttura/structure: 303 bronzo  
 vetro/glass: 67 riflettente chiaro  
 ripiani interni in vetro/glass internal shelves:  
 63 grigio trasparente

basamento, top, cassettera e schienale/  
 base, top, drawer unit and back panel: 15 noce  
 interno cassetti e top cassettera in similpelle/  
 synthetic leather internal drawers and lower  
 top: 153 castoro



DIMENSIONI  
DIMENSIONS

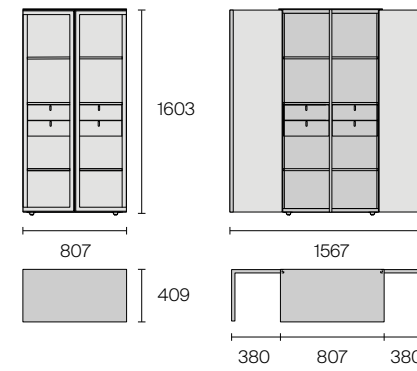

DESCRIZIONE TECNICA  
TECHNICAL DESCRIPTION

EN Aluminium structural thicknesses are minimized so that the transparent glass and the integrated LED lighting system can best enhance the objects on display. The doors are made of reflective glass and equipped with a key locking system. The internal shelves are in transparent grey glass, the aluminium structure is in bronze finishing. Top, base, backpanel and central drawer unit are in noce wood. The drawer unit's top and the drawers' interior are equipped with synthetic leather available in 7 colours. The optional LED lighting is integrated under the shelves, top and drawer unit.

IT Gli spessori strutturali in alluminio sono ridotti al minimo, in modo che il vetro trasparente ed il sistema d'illuminazione a led integrato possano valorizzare al meglio gli oggetti esposti. Le ante sono realizzate in vetro riflettente chiaro e dotate di serratura di chiusura. I ripiani interni sono in vetro grigio trasparente, la struttura in alluminio è in finitura bronzo. Top, basamento, schienale e cassetteria centrale sono in noce. Il top cassetteria e l'interno dei cassetti sono dotati di rivestimento in similpelle disponibile in 7 colori. L'illuminazione led è opzionale ed è incorporata nei ripiani, nel top e sotto la cassetteria.

DE Die Stärke der Aluminiumstruktur ist auf ein Minimum reduziert, damit das transparente Glas und das integrierte LED-Beleuchtungssystem die Exponate optimal zur Geltung bringen können. Die Türen sind aus Glas 67 reflektente klar und mit einem Schloss ausgestattet. Die Innenregale sind aus 63 transparente grigio Glas und die Aluminiumstruktur ist 303 bronzo lackiert. Abdeckplatte, Basisboden, Rückwand und Schubladen sind in Nussbaum. Die Abdeckplatte und die Innenschubladen sind mit Kunstleder ausgestattet, welches in 7 Farben erhältlich ist. Die LED-Beleuchtung ist optional und in den Fachböden, unten der Abdeckplatte und unter der Schubladen integriert.

FR Les épaisseurs structurelles en aluminium sont réduites au minimum, afin que le verre transparent et le système d'éclairage à LED intégré puissent mieux mettre en valeur les objets exposés. Les portes sont en verre transparent réfléchissant et équipées d'une serrure. Les étagères internes sont en verre gris transparent, la structure en aluminium est en finition bronze. Plateau, base, dos et tiroirs en partie centrale en noyer. Le dessus et l'intérieur des tiroirs sont équipés d'un revêtement en similicuir disponible en 7 coloris. L'éclairage LED est optionnel et est intégré.

ES Los espesores estructurales en aluminio se reducen al mínimo, de modo que el cristal transparente y el sistema de iluminación LED integrado pueden realzar mejor los objetos expuestos. Las puertas están hechas en cristal reflectante claro y están equipadas con una cerradura. Los estantes internos son en cristal gris transparente, la estructura en aluminio es en acabado bronzo. Top, base, panel trasero y cajonera central en nogal. El top de la cajonera y el interior de los cajones están revestidos en simil cuero disponible en 7 colores. La iluminación LED es opcional y está incorporada en los estantes, en el top y debajo de la cajonera.

FINITURE  
FINISHINGS

Struttura  
Structure

LACCATO METALLIZZATO  
LACQUERED METALIZED



303 bronzo

Top

VETRO METALLIZZATO  
METALIZED GLASS



136 bronzo opaco

Ante  
Doors

VETRO TRASPARENTE  
TRANSPARENT GLASS

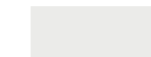

67 riflettente chiaro

Ripiano  
Shelf

VETRO TRASPARENTE  
TRANSPARENT GLASS



63 grigio trasparente

Top, basamento, schienale interno e cassetti in legno  
Wooden top, wooden base, internal back panel and wooden drawers unit

ESSENZA/WOOD



15 noce

Interno cassetti e top cassetteria  
Internal drawers and lower top

SIMILPELLE/SYNTHETIC LEATHER



157 arena

158 agata

155 nube

154 argilla

153 castoro

159 etna

156 rubens



ECOLORSYSTEM  
VETRO LACCATO/LACQUERED GLASS

GLOSSY MAT		GLOSSY MAT		GLOSSY MAT		GLOSSY MAT		GLOSSY MAT		GLOSSY MAT			
305	138 cipria	45	97 avorio	59	105 grigio chiaro	40	115 grigio cenere	53	95 bianco neve	50	108 bianco latte		
51	113 nocciola	52	107 corda	56	98 lino	312	145 grigio seta	47	96 grigio perla	78	114 sabbia		
306	139 terracotta	85	130 tufo	310	143 creta	38	121 azzurro cera	36	117 blu Londra	74	110 canapa		
76	116 rosso india	308	141 pepe	317	600 grigio artico	35	100 blu notte	39	122 verde inglese	73	109 giallo kashmir		
75	129 amaranto	309	142 sandalo	88	132 grigio scuro	86	131 blu oceano	314	147 verde lichene	43	119 laguna		
307	140 java	58	99 caffè	311	144 grigio lava	313	146 blu scuro	315	148 verde scuro	33	111 verde oliva		
		84	128 moro	46	102 nero					316	149 verde terra		

ECOLORSYSTEM  
VETRO SAHARA/SAHARA GLASS

505	cipria sahara	508	pepe sahara	520	grigio chiaro sahara	512	grigio seta sahara	514	verde lichene sahara	523	verde oliva sahara
506	terracotta sahara	509	sandalo sahara	517	lino sahara	522	blu oceano sahara	515	verde scuro sahara	516	verde terra sahara
507	amaranto sahara	519	caffè sahara	510	creta sahara	513	blu scuro sahara				
				524	grigio artico sahara						
				521	grigio scuro sahara						
				511	grigio lava sahara						

ECOLORSYSTEM  
VETRO METALLIZZATO/METALIZED GLASS

GLOSSY MAT		GLOSSY MAT		SAHARA		SAHARA		DIAMANTE		DIAMANTE			
304	137 platino	302	135 grafite	504	platino sahara	502	grafite sahara	404	platino diamante	402	grafite diamante		
69	126 palladio	303	136 bronzo	569	palladio sahara	503	bronzo sahara	469	palladio diamante	403	bronzo diamante		
83	127 piombo	300	133 rame	583	piombo sahara	500	rame sahara	483	piombo diamante	400	rame diamante		
301	134 petro			501	petro sahara			401	petro diamante				

VETRO NEUTRO NEUTRAL GLASS		VETRO TRASPARENTE TRANSPARENT GLASS		VETRO SATINATO SATINATED GLASS		VETRO RETE MESH GLASS		VETRO REFLEX REFLEX GLASS			
55	specchio	590	trasparente sahara	67	riflettente chiaro	591	acidato sahara	60	rete alluminio	90	bianco reflex
68	specchio grigio	490	trasparente diamante	64	riflettente grigio	02	acidato extrachiaro	61	rete inox	92	kaki reflex
		05	trasparente extrachiaro	81	riflettente bronzo	01	acidato	62	rete bronzo	94	cacao reflex
		00	trasparente			03	acidato grigio	66	maglia gold	89	nero reflex
		63	grigio trasparente			04	acidato bronzo	87	maglia rame		
		65	bronzo trasparente			82	nuvola extrachiaro	06	fibra argento		
		390	verde trasparente			80	nuvola	08	fibra bronzo		
		391	blu trasparente								

ECOLORSYSTEM  
LACCATO OPACO/MAT LACQUERED



ECOLORSYSTEM  
LACCATO METALLIZZATO/LACQUERED METALIZED



ALLUMINIO GRAFFIATO  
SCRAPED ALUMINIUM



ALLUMINIO  
ALUMINIUM

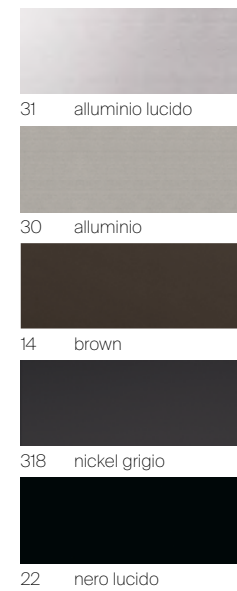

CUOIO  
LEATHER

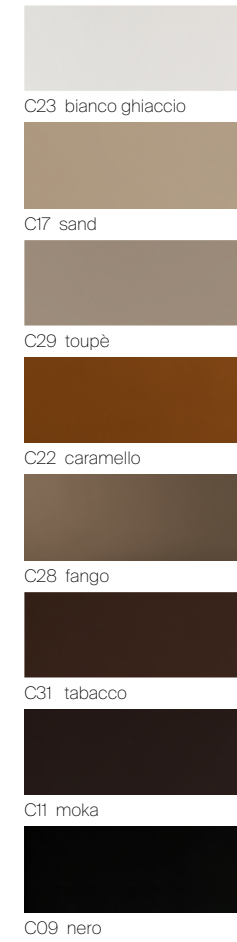

SIMILPELLE  
SYNTHETIC LEATHER



TESSUTO LUX  
LUX FABRIC



TESSUTO MATERIAL  
MATERIAL FABRIC



MARMO  
MARBLE

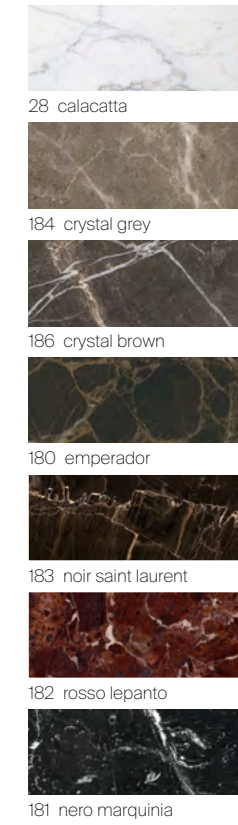

MARMO OPACO  
MAT MARBLE

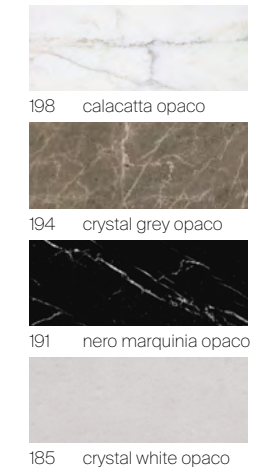

LITECH

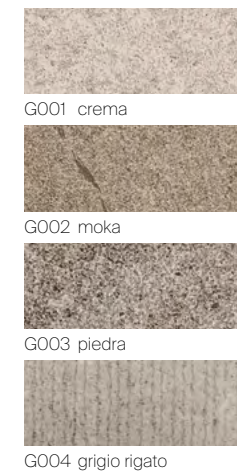

ESSENZA  
WOOD



ESSENZA SAHARA  
SAHARA WOOD



ESSENZA TAIGA  
TAIGA WOOD



MELAMINICO  
MELAMINE



MELAMINICO INTERNO  
INTERNAL MELAMINE



# TEXTS

THE GOOD LIVING  
P. 3

DE Mit The Good Living tritt das besondere Designkonzept von Rimadesio ins Rampenlicht, bei dem Technologie, Materialforschung und Produktauswahl eine Schlüsselrolle spielen. Ein Design, das die Möglichkeit eines neuen Lebensstils aufzeigt, eine ideale Dimension, in der wir unsere Wohnvorstellungen und die Beziehung zur Umwelt, in der wir leben, besser ins Gleichgewicht bringen können.

FR Avec The Good Living, c'est l'idée de conception particulière de Rimadesio, où la technologie, la recherche sur les matériaux et les choix de production jouent un rôle fondamental, qui entre en scène. Une conception qui suggère un nouveau style de vie, une dimension idéale pour tendre vers un meilleur équilibre entre le plaisir d'habiter un lieu et la relation avec l'espace dans lequel nous vivons.

ES The Good Living materializa la particular idea del diseño de Rimadesio, en la que la tecnología, la investigación de los materiales y las distintas opciones relativas a la producción juegan un papel fundamental. Un diseño que invoca un nuevo estilo de vida, una dimensión ideal para luchar por un mayor equilibrio entre la emoción de ocupar un espacio propio y la relación con el entorno en el que vivimos.

LIVING  
STRIPE, ZENIT, TRAY, SELF PLAN, ALAMBRA,  
PLANET  
P. 6

DE Mit ihrem konsequenten Design und den wertvollen Materialien bilden die Stripe-Schiebetüren einen praktischen Sichtschutz zwischen dem Eingangsbereich des Hauses und dem großen, hellen Wohnbereich. Hier stehen sich auf den gegenüberliegenden Seiten der Sofalandschaft eine Zenit-Bibliothekswand und eine wandhängende Self-Plan-Komposition gegenüber. Durch ihre zueinander komplementäre Funktion tragen die Systeme entscheidend zur kompositorischen Ordnung und stilistischen Modernität bei, die den Raum prägen.

FR Rigoureuses dans leur conception, réalisées en matériaux précieux, les portes coulissantes Stripe constituent un écran pratique entre la zone d'entrée de la maison et le vaste et lumineux espace de vie. Ici, de part et d'autre de l'espace canapé, une bibliothèque de séparation Zenit et une composition murale suspendue Self plan se font face. Complémentaires du point de vue fonctionnel, ces systèmes aident à définir l'ordre, la composition et la modernité stylistique qui caractérisent l'espace.

ES Con un riguroso diseño y unos materiales de primera calidad, las puertas correderas Stripe crean un práctico panel de separación entre la zona de entrada y el amplio y luminoso salón. Aquí, en los lados opuestos a la zona de sofás, aparecen enfrentadas la librería Zenit, en forma de pared intermedia, y la composición Self plan suspendida desde la pared. Complementarios entre sí desde el punto de vista funcional, estos sistemas contribuyen a definir el orden compositivo y la modernidad estilística que caracterizan el espacio.

DINING  
MODULOR, RADIUS, ALIANTE, FRANCIS  
P. 30

DE Die neue Oberfläche Eiche Taiga, die sowohl bei der Modulor-Verkleidung als auch bei den Radius-Türen zum Einsatz kommt, bereichert die Dining-Landschaft mit ihrem zarten grafischen Design. Der Tisch Francis in runder Ausführung nimmt die Mitte des Raumes ein, während an den Seiten zwei Aliante-Glassideboards die symmetrische Anordnung betonen. Das Ergebnis ist ein helles und kohärentes Ambiente, in dem nichts zufällig ist: vom raffinierten Design der verschiedenen Möbelkomponenten über die technische und funktionelle Qualität der Öffnungsbewegungen bis hin zur ausgeklügelten Kombination von Materialien und Oberflächen.

FR Présente tant sur les boiseries Modulor que sur les portes Radius, la nouvelle finition chêne Taïga met en valeur la salle à manger avec son graphisme délicat. La table Francis dans sa version ronde occupe le centre de l'espace, tandis que de part et d'autre, deux buffets en verre Aliante soulignent la disposition symétrique. L'ambiance qui se dégage est lumineuse et cohérente, et rien n'est laissé au hasard : du design raffiné des différents éléments d'ameublement à la qualité technique et fonctionnelle des mouvements d'ouverture, jusqu'à la combinaison sophistiquée des matériaux et des finitions.

ES Presente tanto en la boiserie Modulor como en las puertas Radius, el nuevo acabado roble Taiga embellece el ambiente del comedor con su delicado diseño gráfico. La versión redonda de la mesa Francis ocupa el centro del espacio, mientras que a los lados dos aparadores de vidrio Aliante enfatizan la disposición simétrica. El resultado es un ambiente luminoso y coherente, en el que nada es casual: desde el diseño refinado de los distintos componentes del mobiliario hasta la calidad técnica y funcional de los movimientos de apertura, pasando por la sofisticada combinación de materiales y acabados.

NIGHT  
SELF PLAN, SELF BOLD, RADIUS, PLANET  
P. 32

DE Die durch eine große Schreibtischplatte ergänzte Self-Plan-Komposition eröffnet eine neue Möglichkeit, den Raum für die Nacht zu erleben. Zwei ebenso unabdingbare wie diskrete niedrige Planet-Tische ergänzen das Bett, während die Radius-Türen in Kunstlederausführung den Raum mit dem Kleiderschrankbereich verbinden. Im Zusammenspiel mit ihrer je spezifischen Funktion trägt jede Komponente der Einrichtung dazu bei, ein kohärentes Ganzes zu definieren, in den Farben und Texturen der Materialien, in der Wesentlichkeit des Designs und in der Aufmerksamkeit, die jedem einzelnen Detail zuteilwird.

FR Enrichie d'un grand plan de bureau, cette composition Self plan suggère une manière différente d'expérimenter l'espace nuit. Essentielles et discrètes, deux tables basses Planet sont au service du lit, tandis que les portes Radius dans la version similicuir relient cette zone à l'espace penderie. Avec sa fonction spécifique, chaque élément mobilier participe à la définition d'un ensemble cohérent, par les couleurs et textures des matériaux, par le caractère essentiel du design et l'attention portée au moindre détail.

ES La composición Self plan integra una amplia superficie de escritorio para ofrecer una forma diferente de vivir el espacio noche. Esenciales y discretas, dos mesas bajas Planet escoltan la cama, mientras que las puertas Radius en versión similpiel conectan el espacio con la zona de armarios. Paralelamente a su función específica, cada componente del mobiliario ayuda a definir un todo coherente, a través de los colores y las texturas de los materiales, en la esencialidad del diseño y la atención a cada detalle.

WALK-IN CLOSET  
ZENIT, COVER  
P. 50

DE Umrahmt von durchgehenden Wänden aus Cover-Garderoben, steht im Zentrum des Garderobenraums eine Zenit-Komposition, hier in der Ausführung als begehrter Kleiderschrank. Die Helligkeit des Arena-Kunstleders der Cover-Türen bildet so den Hintergrund für die Strenge des bronzefarbenen Aluminiums von Zenit, deren gegenüber der letzten Version aktualisierte Einrichtungen die typischen Organisationsanforderungen der verschiedenen Funktionen auf originelle Weise erfüllen.

FR Encadré par les parois pleines des armoires Cover, l'espace penderie présente au centre une composition Zenit, ici en version dressing. Le brillant du similicuir Arena recouvrant les portes de Cover sert ainsi d'arrière-plan à la rigueur de l'aluminium en finition bronze de Zenit, tandis que son équipement actualisé par rapport à la version la plus récente résout avec originalité les habituels besoins d'organisation des différentes fonctions.

ES Enmarcado por paredes continuas de armarios Cover, el espacio guardarropa presenta una composición Zenit en el centro, aquí en versión vestidor. La luminosidad de la similpiel Arena de las puertas de Cover sirve así de fondo al rigor del aluminio en acabado bronce de Zenit, mientras que los accesorios de esta última, actualizados respecto a la versión más reciente, resuelven con originalidad las típicas necesidades de organización de las diferentes funciones.

Collection designed by Giuseppe Bavuso

Concept and art direction: Juma  
Render: Inside Group Technology  
Styling: Simona Silenzi Studio with Gaia Marchesini, Giordano Sarno

June 2022

RIMADESIO SPA  
Via Furlanelli 96  
20833 Giussano (MB) Italy  
T +39 0362 3171  
rimadesio@rimadesio.it

MILANO FLAGSHIP STORE  
via Visconti di Modrone 26  
20122 Milano Italy  
T +39 02 76280708  
milano@rimadesio.it

LONDON FLAGSHIP STORE  
83-85, Wigmore street  
1WU 1DL London  
T +44 2074 862193  
london@rimadesio.co.uk

NEW YORK FLAGSHIP STORE  
102 Madison Ave  
New York, NY 10016  
T +1 917 388 2650  
newyork@rimadesio.us

[www.rimadesio.it](http://www.rimadesio.it)

Italy showroom:  
Milano, Roma, Genova, Torino, Como, Parma, Firenze, Palermo, Catania,  
Cosenza, Salerno.

Worldwide showroom:  
Oxford, Genève, Bern, Lucerne, Wien, Frankfurt, Hamburg, Munich, Nice,  
Madrid, Barcelona, Bilbao, Marbella, Moraira, Valencia, Vigo, Bruxelles,  
Moscow, Saint Petersburg, Istanbul, Kiev, Odessa, Beirut, Nicosia, Tokyo,  
Seoul, Shanghai, Wuxi, Ningbo, Suzhou, Zhengzhou, Guangzhou, Shenzhen,  
Dongguan, Hong Kong, Taipei, Manila, New Delhi, Ahmedabad, Bangalore,  
Riyad, Kuwait City, Casablanca, New York, Chicago, Miami, Houston, Mexico  
City, Bogotá, Cape Town, Sydney, Melbourne.

#### Awards

1993	Siparium	Young & Design
2000	Zenit	Award KBB
2001	Zenit	selection Design Index ADI
2002	Siparium	Top100 Frames
2005	Graphis	selection Design Index ADI
2007	Vela	selection Design Index ADI
2008	Vela	mention XXI Premio Compasso d'Oro ADI
2015	Wind	winner Red Dot Award
2016	Cover	Best Furniture System AZ Award
2016	Alambra	selection Design Index ADI
2017	Sail	selection Design Index ADI
2017	Soho	Architectural products AZ awards
2017	Daimon	Interior Design Magazine Best of Year awards
2020	Modulor	People's Choice winner AZ Awards
2020	Modulor	Architectural Products Award of Merit AZ Awards
2020	Modulor	selection Design Index ADI
2021	Francis	selection Design Index ADI

#### Modelli depositati e brevettati/Patented:

Aliante, Radius, Maxi, Sail, Soho, Velaria, Stripe, Daimon, Graphis, Siparium, Zen,  
Zen frame, Moon, Vela, Luxor, Even, Aura, Spin, Link+, Planet, Flat, Alambra, Abacus  
living, Self, Cover, Zenit, Dress bold e Abacus.

#### Marchi registrati/Registered trademarks:

Rimadesio, Ecolormsystem, Litech, Siparium, Velaria, Abacus.



Follow us on Facebook, Instagram, WeChat.

# NEWS 2022

THE GOOD LIVING

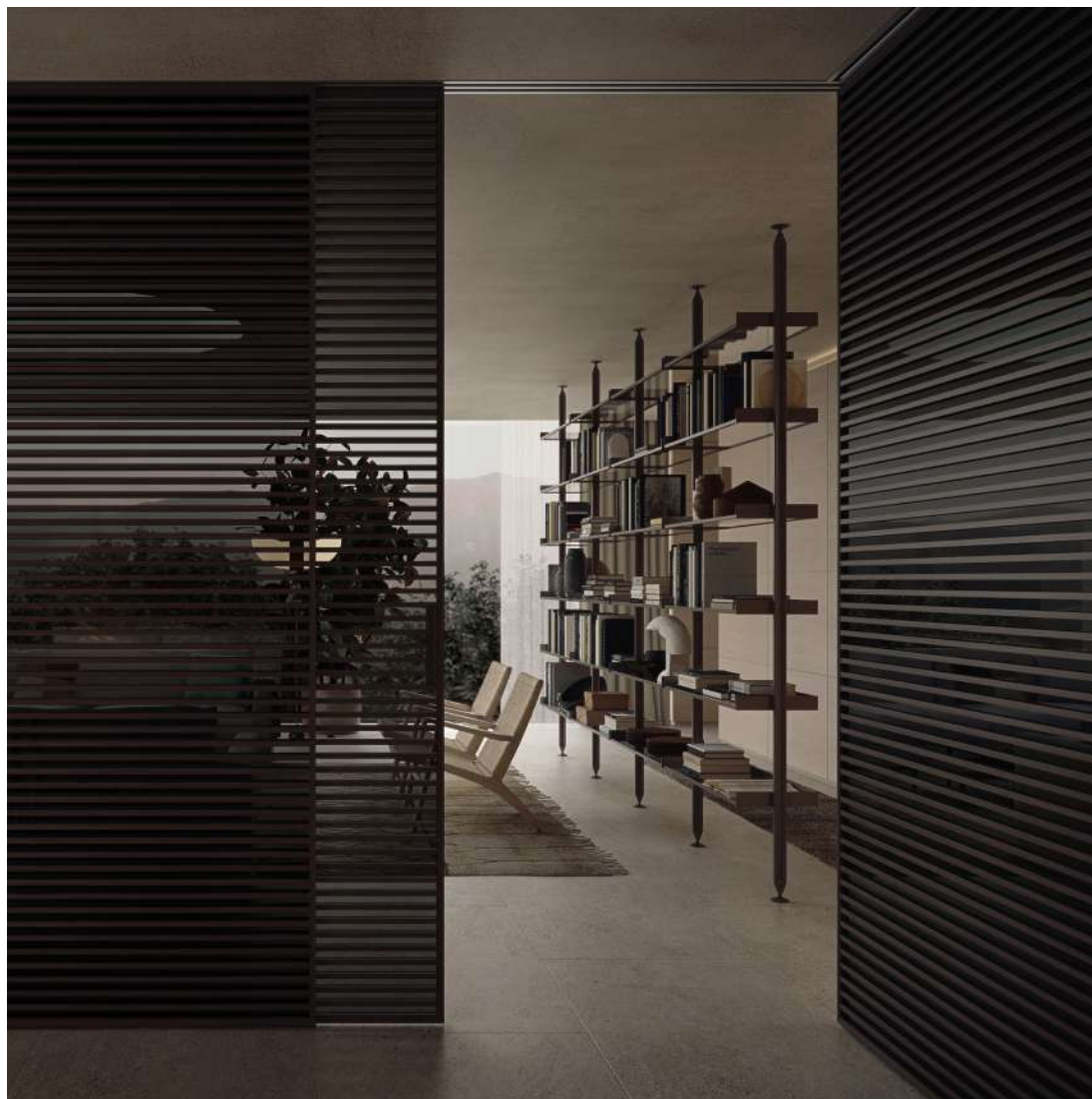

Rimadesio

EN WITH THE GOOD LIVING RIMADESIO'S SPECIAL DESIGN IDEA IS PRESENTED, WHERE TECHNOLOGY, RESEARCH INTO MATERIALS AND PRODUCTION CHOICES PLAY A FUNDAMENTAL ROLE. A DESIGN SUGGESTIVE OF A NEW LIFESTYLE, AN IDEAL SOLUTION TO ACHIEVE A BETTER BALANCE BETWEEN THE EMOTION OF LIVING AND THE RELATIONSHIP WITH THE ENVIRONMENT IN WHICH WE LIVE.

IT CON THE GOOD LIVING VA IN SCENA LA PARTICOLARE IDEA DI DESIGN RIMADESIO, IN CUI TECNOLOGIA, RICERCA SUI MATERIALI E SCELTE PRODUTTIVE SVOLGONO UN RUOLO FONDAMENTALE. UN DESIGN CHE SUGGERISCE UN NUOVO STILE DI VITA, UNA DIMENSIONE IDEALE, TESA AD UN MIGLIORE EQUILIBRIO TRA L'EMOZIONE DELL'ABITARE E IL RAPPORTO CON L'AMBIENTE IN CUI VIVIAMO.

LIVING	
STRIPE, ZENIT, MODULOR, SELF PLAN	7
DINING	
MODULOR, RADIUS, ALIANTE, FRANCIS	31
NIGHT	
SELF PLAN, SELF BOLD, RADIUS, PLANET	43
WALK-IN CLOSET	
ZENIT, COVER	53
TECHNICAL DATA	
TAIGA, NEW FINISHING	65
RADIUS	69
SELF	81
ZENIT BOOKCASE	89
ZENIT WALK-IN CLOSET	95
COVER	101
ALIANTE	107
MATERIALS AND FINISHINGS	113
TEXTS	117



# STRIPE, ZENIT, MODULOR, SELF PLAN

EN RIGOROUSLY DESIGNED WITH PRECIOUS MATERIALS, STRIPE SLIDING DOORS FORM A PRACTICAL SCREEN BETWEEN THE HOUSE ENTRANCE AREA AND THE LARGE, BRIGHT LIVING AREA. HERE, ON THE OPPOSITE SIDES OF THE SOFA AREA, A ZENIT BOOKCASE AND A SELF PLAN WALL-HUNG STRUCTURE FACE EACH OTHER. PLAYING MUTUALLY COMPLEMENTARY FUNCTIONS, THE SYSTEMS HELP TO DEFINE THE COMPOSITIONAL ORDER AND STYLISTIC MODERNITY THAT CHARACTERISE THE SPACE.

IT RIGOROSE NEL DISEGNO E PREZIOSE NEI MATERIALI, LE ANTE SCORREVOLI STRIPE COSTITUISCONO UN PRATICO SCHERMO TRA L'AMBIENTE D'INGRESSO DELLA CASA E L'AMPIA E LUMINOSA AREA LIVING. QUI, SUI LATI OPPOSTI DELLA ZONA DIVANI, SI FRONTEGGIANO UNA LIBRERIA INTERPARETE ZENIT E UNA COMPOSIZIONE SOSPESA A PARETE SELF PLAN. TRA LORO COMPLEMENTARI SUL PIANO FUNZIONALE, I SISTEMI CONTRIBUISCONO A DEFINIRE L'ORDINE COMPOSITIVO E LA MODERNITÀ STILISTICA CHE CARATTERIZZANO LO SPAZIO.







EN The Rimadesio materials collection is enriched with two new types of wood: oak and ebony-stained: oak and ebony-stained, both available in the new taiga finish. The surface is marked by a finely striped horizontal texture, obtained through a mechanical pressing process that gives the material a three-dimensional relief that is soft to the touch. In both essences, the taiga finish is available on 15 products in the collection: from the sideboards to the hinged doors, from the doors of the night storage units to the panels of the Modulor paneling system.

IT La collezione materiali Rimadesio si arricchisce di due nuove essenze: rovere e tinto ebanò, entrambe disponibili nell'inedita finitura taiga. La superficie è scandita da una texture orizzontale finemente rigata, ottenuta con un processo di pressatura meccanica che dona alla materia un rilievo tridimensionale, morbido al tatto. In entrambe le essenze, la finitura taiga è disponibile su 15 prodotti della collezione: dalle madie alle porte battenti, dalle ante dei contenitori notte ai pannelli del sistema boiserie Modulor.

RU Коллекция материалов Rimadesio пополнилась двумя вариантами шпона: это дуб натуральный и тонированной под эбеновое дерево, оба они доступны в новейшей отделке taiga. Поверхности с такой отделкой имеют текстуру с мельчайшим рифлением по всей площади, такой эффект достигается с помощью механического прессования, придающего материалу трехмерный рельеф, мягкий на ощупь. Оба варианта шпона предлагаются в отделке taiga, которая доступна для 15 линеек продукции из коллекции фабрики: от тумб до распашных дверей, от дверей модулей для ночного хранения до стеновых панелей-буазери системы Modulor.

汉语 Rimadesio推出的材料系列新增了两款木质：橡木与染色黑檀木，两种木质皆可选Taiga饰面。表面带有横向细纹纹理，通过机械式磨削加工制成，使材料获得立体的浮雕饰纹，柔和的触感。Taiga饰面的两种新木质，可运用在系列中的15项产品：从边柜到平开门，从卧室收纳柜柜门到Modulor系统的装饰镶板。

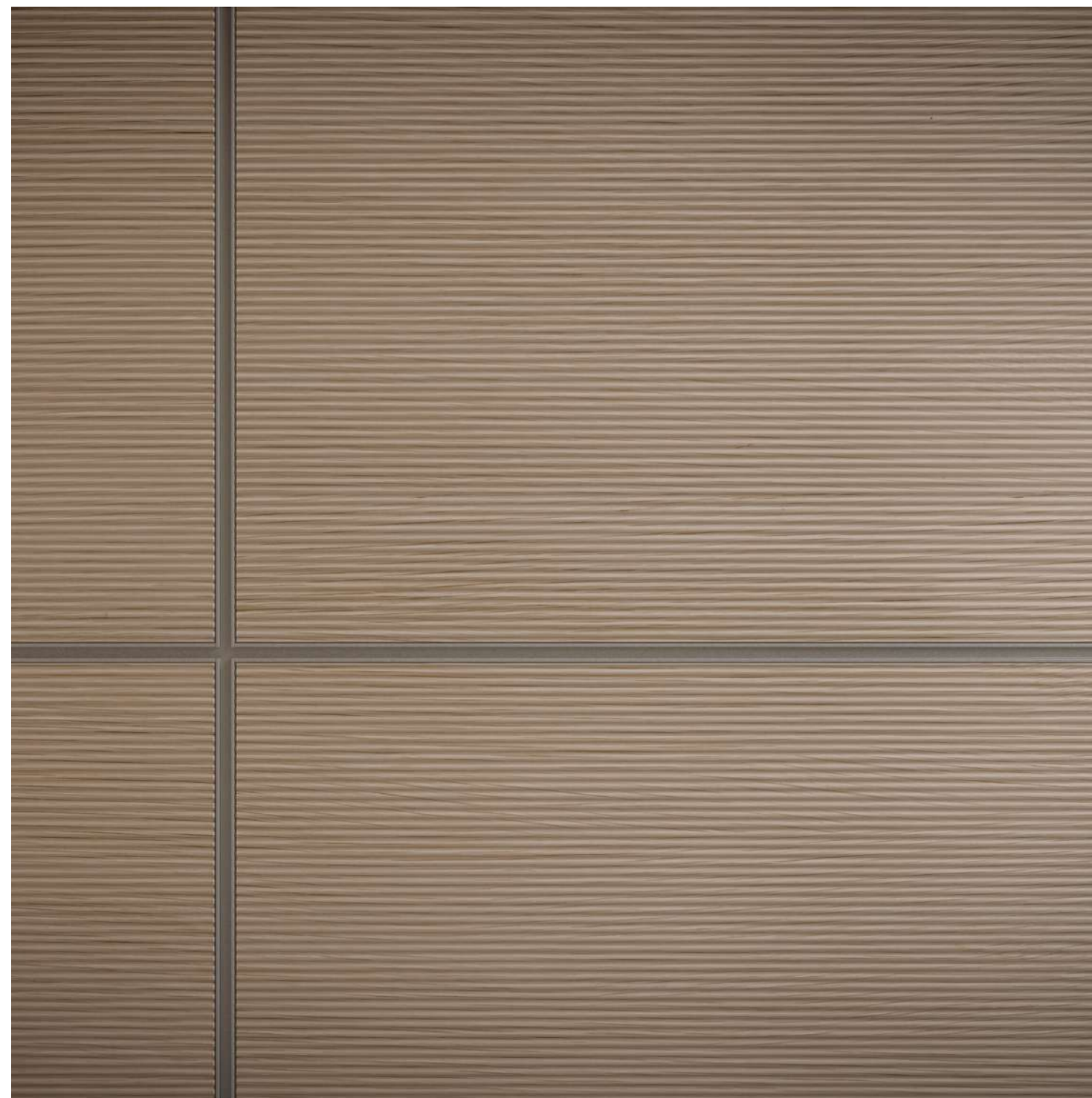



EN In the bookcase version, Zenit now expands its design potential with the introduction of a brand new backlit upright and new suspended units which, like all Zenit facilities, can be freely positioned. The new design includes a chest of drawers, a unit with doors, a chest of drawers with bottom-hinged frame. With their fully extractable runners, the aluminium drawers are also new and come equipped with a unique push opening system and soft-closing mechanism. The drawer and door coating is available in glossy, opaque, reflex, sahara, diamond lacquered glass or in Litech or Sahara and Taiga essence with three-dimensional effect, for a total of 161 finishes. The unit D 340 with bottom-hinged frame is lined inside with synthetic leather in 7 available finishes: Arena, Nube, Argilla, Castoro, Rubens, Etna and Agata.

IT Nella versione libreria Zenit amplia oggi le proprie potenzialità progettuali con l'introduzione di un inedito montante retroilluminato e di nuovi contenitori sospesi che, come tutte le attrezzature di Zenit, sono liberamente posizionabili. La nuova proposta comprende: cassetiera, contenitore con ante, cassetiera con anta ribalta e cassetto. Nuovi anche i cassetti in alluminio, con guide ad estrazione totale e dotati di un inedito sistema di apertura push e rientro ammortizzato. Il rivestimento dei cassetti e delle ante è disponibile in vetro laccato lucido, opaco, reflex, sahara, diamante oppure in Litech, in essenza Sahara e Taiga con effetto tridimensionale, per un totale di 161 finiture. Il contenitore con anta a ribalta P 340 è rivestito internamente in similpelle nelle 7 finiture previste: Arena, Nube, Argilla, Castoro, Rubens, Etna e Agata.

RU Библиотека Zenit сегодня дарит новые возможности для проектирования с появлением новой стойки с подсветкой и новых подвесных модулей хранения, которые, как и все аксессуары Zenit, размещаются произвольно в любом желаемом месте. Новое предложение включает в себя: комод, модуль с распашными дверцами, модуль с откидной дверью и выдвижной ящик. Кроме того, последняя версия включает новые алюминиевые ящики с направляющими, допускающими полное выдвижение ящика, и оснащенными новейшей системой открывания push и плавного закрывания. Для внешней облицовки фасадов ящиков и распашных дверей фабрика предлагает гляцевое или матовое окрашенное стекло, зеркальное стекло, стекло sahara с волнистой поверхностью, мерцающее стекло diamante, эксклюзивный материал Litech, шпон древесины с волнистой поверхностью sahara или с отделкой taiga с трехмерным эффектом: в общей сложности предлагается 161 вариант отделки. Модуль с откидной дверцей глубиной 340 мм полностью обтянут синтетической кожей, можно выбрать один из 7 предлагаемых цветов: Arena, Nube, Argilla, Castoro, Rubens, Etna и Agata.

汉语 书架版本的Zenit，今日有了扩增设计潜力的新元素，如前所未有的背光支撑架与新款悬挂式收纳柜。也如同Zenit其他组件般，皆可自由地摆放配置。新组件包括有：抽屉柜、带柜门收纳柜、带掀式柜门的抽屉柜与抽屉。新品中也包括了铝质抽屉，带导轨并可完全抽出，并配备全新的按压式开启以及缓冲阻尼关闭系统。抽屉与门板的饰面可选：烤漆玻璃——亮光、哑光、反光、Sahara、水晶；Litech陶质；木质——Sahara与三维效果的Taiga。共161种饰面。掀式柜门收纳柜P 340则完全外覆合成皮，7种饰面可选：Arena、Nube、Argilla、Castoro、Rubens、Etna与Agata。



ZENIT  
struttura/structure: 206 bronzo graffiato  
frontali cassettiere/frontal drawers: 701 rovere taiga  
interni/internal: UB09 melaminico cuoio brown









ZENIT  
struttura/structure: 206 bronzo graffiato  
frontali/fronts: 701 rovere taiga  
interni/internal: UB09 melaminico cuoio brown





ZENIT  
 struttura/structure: 206 bronzo graffiato  
 frontali/fronts: 701 rovere taiga  
 piano interno in similpelle/synthetic leather  
 internal door cladding top: 154 argilla  
 schienale interno/back internal: 68 specchio grigio

# MODULOR, RADIUS, ALIANTE, FRANCIS

EN PRESENT BOTH ON THE MODULOR PANELING AND ON THE RADIUS DOORS, THE NEW TAIGA OAK FINISH EMBELLISHES YOUR DINING ROOM WITH ITS DELICATE GRAPHIC DESIGN. THE ROUND VERSION OF THE FRANCIS TABLE OCCUPIES THE CENTRE OF THE SPACE, WHILE TWO ALIANTE GLASS SIDEBOARDS EMPHASISE THE SYMMETRICAL LAYOUT ON THE SIDES. THE RESULT IS A BRIGHT AND COHESIVE ENVIRONMENT, WHERE NOTHING IS LEFT TO CHANCE - BE IT THE REFINED DESIGN OF THE VARIOUS FURNISHING COMPONENTS, THE TECHNICAL AND FUNCTIONAL QUALITY OF THE OPENING MOVEMENTS, OR THE SOPHISTICATED COMBINATION OF MATERIALS AND FINISHES.

IT PRESENTE SIA SULLA BOISERIE MODULOR CHE SULLE PORTE RADIUS, LA NUOVA FINITURA ROVERE TAIGA IMPREZIOSISCE L'AMBIENTE DINING CON IL SUO DELICATO DISEGNO GRAFICO. IL TAVOLO FRANCIS IN VERSIONE TONDA OCCUPA IL CENTRO DELLO SPAZIO, MENTRE AI LATI DUE MADIE IN VETRO ALIANTE NE SOTTOLINEANO L'IMPIANTO SIMMETRICO. IL RISULTATO È UN AMBIENTE LUMINOSO E COERENTE, IN CUI NULLA È CASUALE: DAL DESIGN RICERCATO DEI DIVERSI COMPONENTI D'ARREDO ALLA QUALITÀ TECNICA E FUNZIONALE DEI MOVIMENTI DI APERTURA, FINO ALLA SOFISTICATA COMBINAZIONE DEI MATERIALI E DELLE FINITURE.

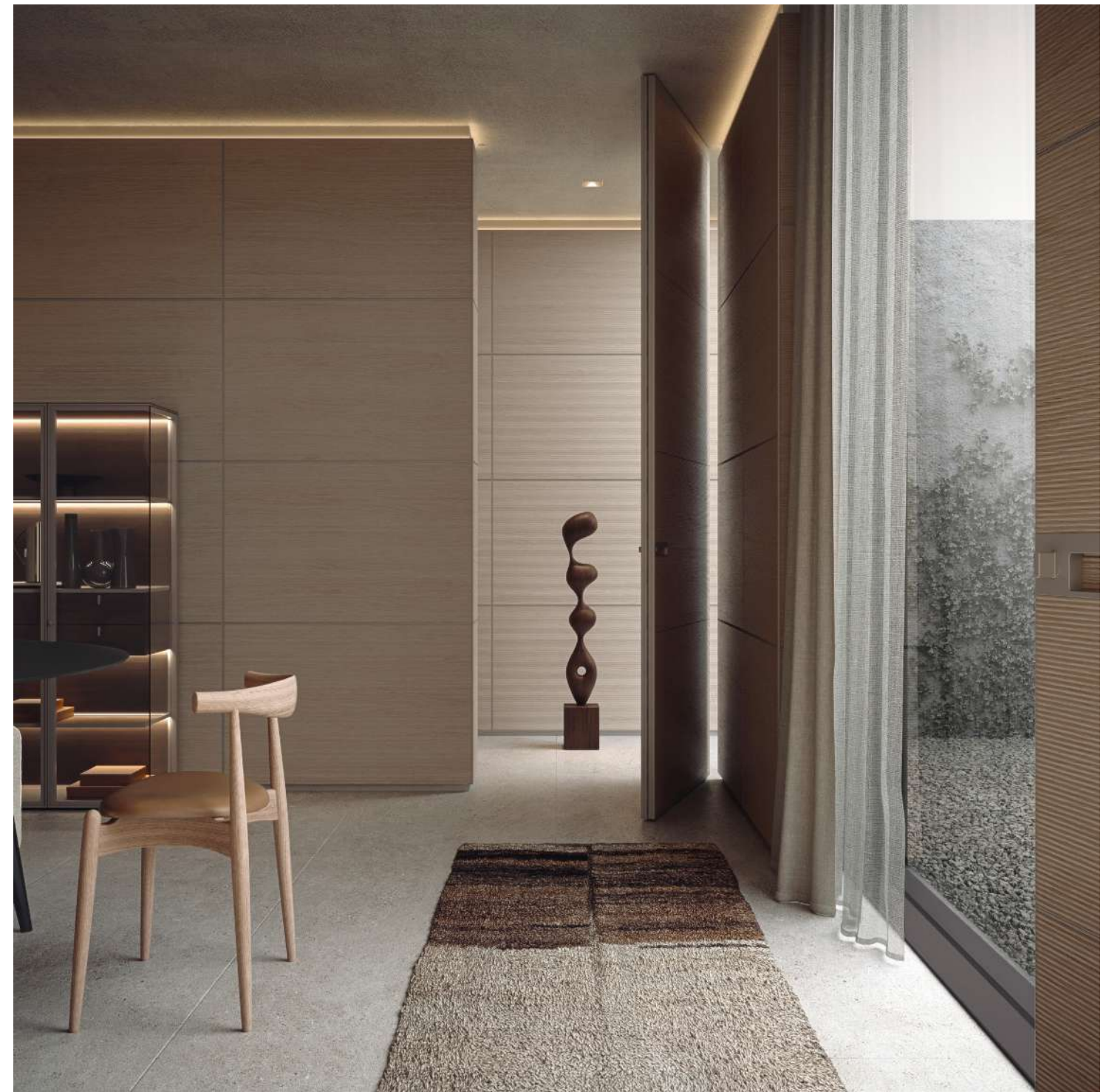



EN Aliante appears as a precious transparent glass cabinet with an original opening system. It is a cabinet with rigorous proportions, which concentrates a series of exclusive technical solutions. These include the special opening of the doors which, with a thin aluminium structure and a special glass assembly technique, exclude the presence of lateral flanks and give the container an extraordinary light and transparent image.

IT Aliante si presenta come uno scrigno prezioso in vetro trasparente, dotato di un inedito sistema di apertura. Un contenitore dalle proporzioni rigorose, che concentra una serie di soluzioni tecniche esclusive. Come la particolare apertura delle ante che, dotate di una sottile struttura in alluminio e di una speciale tecnica di assemblaggio del vetro, escludono la presenza di fianchi laterali e conferiscono al contenitore un'immagine straordinariamente leggera e trasparente.

RU Модель Aliante – это изысканный и утонченный модуль хранения из прозрачного стекла, оснащенный новейшей системой открывания. Он имеет строгие пропорции и воплощает в себе ряд эксклюзивных технологических решений. Одно из них – это оригинальное открывание распашных дверок, обрамленных тонкой алюминиевой рамкой по периметру. Кроме того, благодаря специальной технике установки стекла, модель не имеет внешних боковых стенок, что придает ей необычайную легкость и воздушность.

汉语 犹如珍宝柜以透明玻璃制成的Aliante，配备了一套前所未有的开启系统。在这座比例严谨的收纳柜中，浓缩了一系列专属技术的解决方案。特殊开启方式的柜门，通过纤细的铝质结构、特殊技术组装的玻璃以及排除侧板设计，赋予了收纳柜一种非凡轻盈与透明的形态。



ALIANTE  
struttura/structure: 303 bronzo  
vetro/glass: 67 riflettente chiaro  
ripiani interni in vetro/glass internal shelves:  
63 grigio trasparente  
top cassetiera in similpelle/

synthetic leather lower top: 154 argilla  
basamento, top, cassetiera e schienale/  
base, top, drawer unit and back panel:  
19 rovere termotrattato (non disponibile  
a listino/not available in the price list)

Nella foto/In this photo:  
boiserie/wall paneling system: Modulor





ALIANTE

struttura/structure: 303 bronzo  
 vetro/glass: 67 riflettente chiaro  
 ripiani interni in vetro/glass internal shelves:  
 63 grigio trasparente  
 top cassetiera in similpelle/

synthetic leather lower top: 154 argilla  
 basamento, top, cassetiera e schienale/  
 base, top, drawer unit and back panel:  
 19 rovere termotrattato (non disponibile  
 a listino/not available in the price list)

Nella foto/In this photo:  
 boiserie/wall paneling system: Modulor

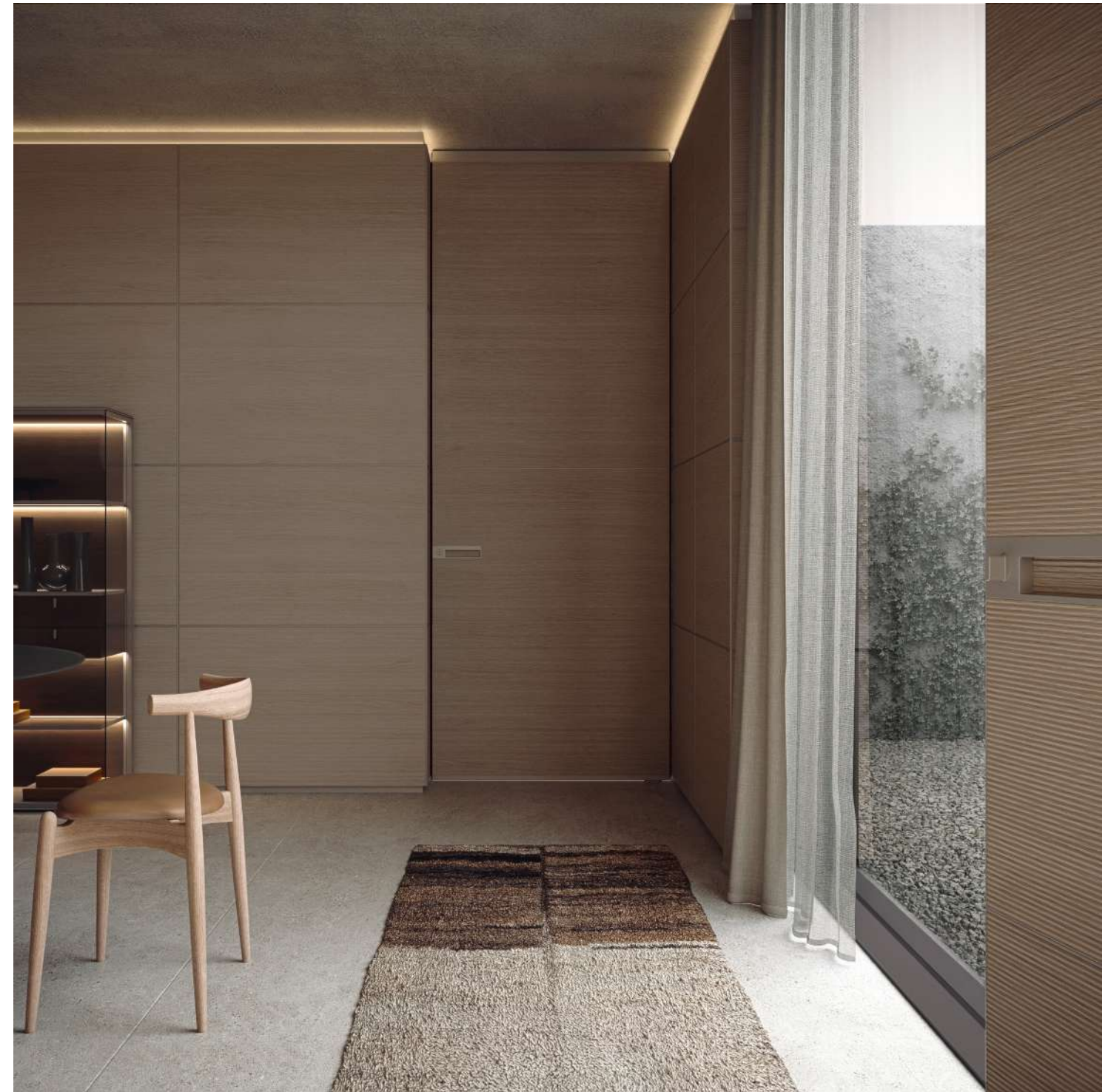
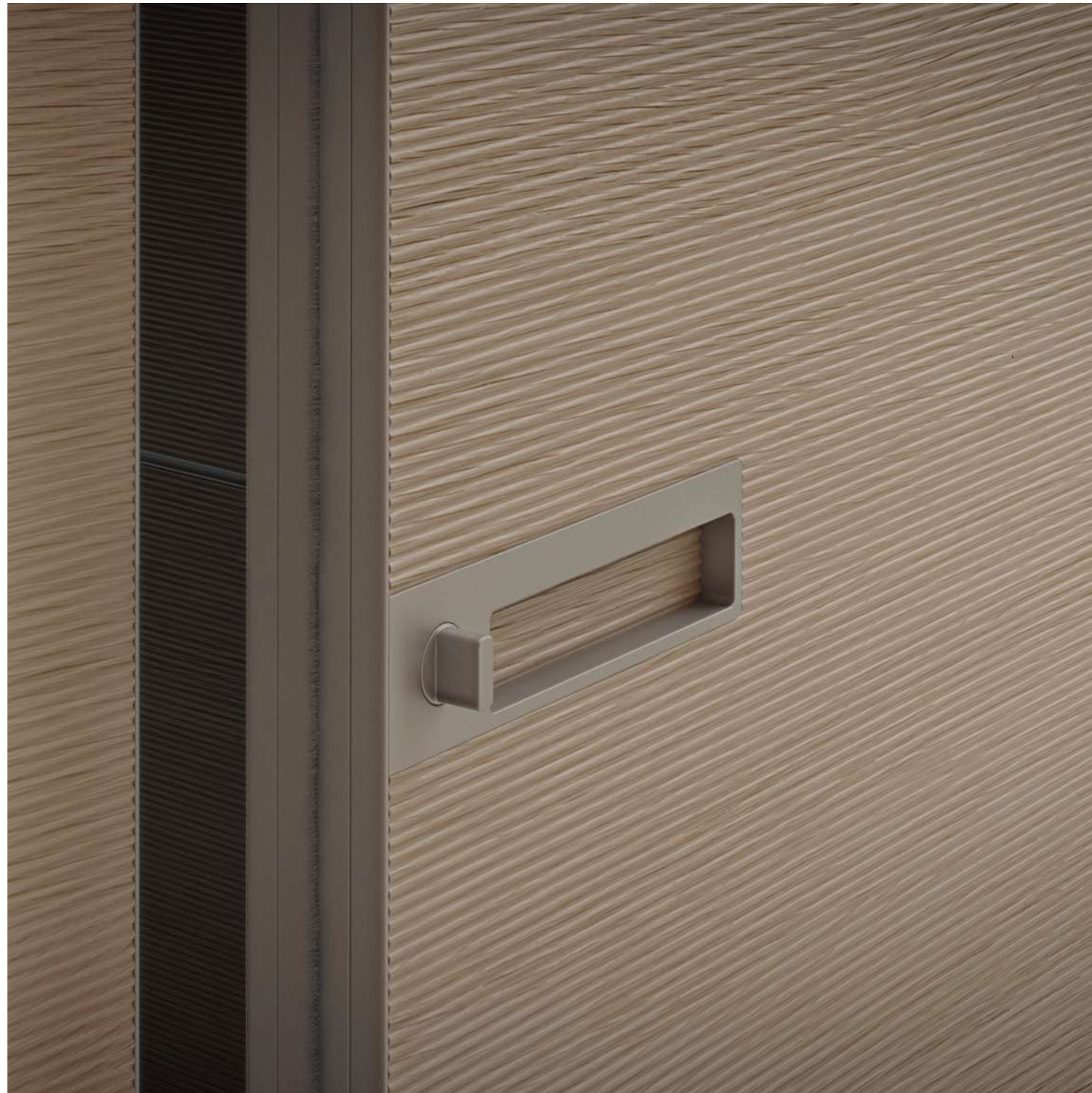

RADIUS  
struttura/structure: 304 platino  
pannello porta/door panel: 701 rovere taiga

MODULOR  
struttura/structure: 304 platino  
rivestimento/cladding: 701 rovere taiga

SELF PLAN, SELF BOLD,  
RADIUS, PLANET

EN ENRICHED BY A LARGE WRITING DESK, A SELF PLAN STRUCTURE SUGGESTS A DIFFERENT WAY OF EXPERIENCING NIGHT SPACES. ESSENTIAL AND DISCREET, TWO PLANET LOW TABLES SERVE THE BED, WHILE THE RADIUS DOORS IN THE SYNTHETIC LEATHER VERSION CONNECT THE SPACE TO THE WARDROBE AREA. TOGETHER WITH THE SPECIFIC FUNCTION, EACH PIECE OF FURNITURE HELPS TO CREATE A COHESIVE WHOLE – IN THE COLOURS AND TEXTURES OF THE MATERIALS, IN THE MINIMALISM OF THE DESIGN AND IN THE ATTENTION TO EVERY DETAIL.

IT ARRICCHITA DA UN AMPIO PIANO SCRITTOIO, UNA COMPOSIZIONE SELF PLAN SUGGERISCE UNA FORMA DIVERSA DI VIVERE LO SPAZIO NOTTE. ESSENZIALI E DISCRETI, DUE TAVOLI BASSI PLANET SONO DI SERVIZIO AL LETTO, MENTRE LE PORTE RADIUS IN VERSIONE SIMILPELLE COLLEGANO LO SPAZIO ALLA ZONA ARMADI. INSIEME ALLA FUNZIONE SPECIFICA, OGNI COMPONENTE D'ARREDO CONTRIBUISCE A DEFINIRE UN INSIEME COERENTE, NELLE CROMIE E NELLE TEXTURES DEI MATERIALI, NELL'ESSENZIALITÀ DEL DISEGNO E NELLA CURA DI OGNI DETTAGLIO.





SELF PLAN  
struttura/structure: 303 bronzo  
piano e schienale in similpelle/synthetic  
leather top and back panel: 154 argilla  
vano a giorno/open module:  
19 rovere termotrattato

SELF BOLD  
struttura/structure: 303 bronzo  
vetro/glass: 403 bronzo diamante

Nella foto/In this photo:  
tavolino/coffee table: Planet

EN Always made to measure in height and width, Radius is available in large dimensions, with panels that reach 3600 mm in height and 1760 mm in width. This is thanks to an extruded aluminium structure designed to give maximum strength and stability in domestic as well as professional, hospitality and retail.

IT Realizzata sempre su misura in altezza e larghezza, Radius è capace di declinarsi su grandi dimensioni, con pannelli che raggiungono 3600 mm in altezza e 1760 mm in larghezza grazie a una struttura in alluminio estruso progettata per conferire massima resistenza e stabilità in contesti domestici oltre che professionali, hospitality e retail.

RU Модель Radius изготавливается по индивидуальным размерам как в высоту, так и в ширину. Дверное полотно может достигать впечатляющих размеров – до 3600 мм в высоту и 1760 мм в ширину – благодаря специальной структуре из экструдированного алюминия, придающей максимум прочности и надежности. Эта модель предназначена для использования как в домашних интерьерах, так и в офисных пространствах, а также в гостиничной сфере и торговых центрах.

汉语 高度与宽度的尺寸始终量身定制, Radius具有适应大型尺寸的能力。面板可达最高3600mm, 最宽1760mm, 结构采用挤压成型的铝材制成, 是专为赋予最大耐用性与稳定性, 为居家环境以及专业、招待和零售领域所设计。



EN Made entirely of aluminium, Self plan is based on horizontal modularity, with a fixed depth of 525 mm and a variable length from 1,616 to 3,856 mm. Wide variety of finishes: the aluminium structure is available in 46 Ecolorsystem colours. In the desk version, the top and the rear riser can be made of glass or synthetic leather, for a total of 106 finishes.

IT Realizzato interamente in alluminio, Self plan è basato su una modularità orizzontale, con profondità fissa di 525 mm e una lunghezza variabile da 1616 a 3856 mm. Ampia la varietà di finiture: la struttura in alluminio è disponibile in 46 colori Ecolorsystem. Nella versione scrittoio, il piano e l'alzata posteriore possono essere realizzati in vetro o similpelle, per un totale di 106 finiture.

RU Полностью алюминиевая система Self Plan имеет в основе горизонтальную полку с фиксированной глубиной 525 мм и длиной от 1616 до 3856 мм. Для этой модели фабрика предлагает широкий выбор отделки: алюминиевая конструкция доступна в 46 цветах эксклюзивной палитры Ecolorsystem. Одно из новейших дополнений линейки Self plan – письменный стол, где столешница и задняя стенка изготовлены из стекла или обтянуты синтетической кожей. Таким образом, для этой модели в общей сложности предлагается 106 уникальных отделок.

汉语 完全采用铝质制成，Self plan以横向模块为基础，深度固定为525mm，长度则从1616到3856mm可变。广泛多种的饰面可选：铝质结构共推出46种Ecolorsystem色彩。于写字台版本，台面与后方加高部分可以选用玻璃或合成皮，共106种饰面



SELF PLAN  
struttura/structure: 303 bronzo  
piano e schienale in similpelle/synthetic  
leather top and back panel: 154 argilla  
vano a giorno/open module:  
19 rovere termotrattato

SELF BOLD  
struttura/structure: 303 bronzo  
vetro/glass: 403 bronzo diamante

# ZENIT, COVER



EN FRAMED BY COVER WARDROBE CURTAIN WALLS, THE WARDROBE SPACE FEATURES A ZENIT STRUCTURE IN THE CENTRE, HERE IN THE WALK-IN CLOSET VERSION. THE BRIGHT ARENA SYNTHETIC LEATHER OF THE COVER DOORS THUS FORMS THE BACKGROUND TO THE RIGOROUS BRONZE FINISH ZENIT ALUMINUM, WHILE THE LATTER'S FIXTURES - UPDATED WITH RESPECT TO THE MOST RECENT VERSION - MEETS THE TYPICAL ORGANISATION NEEDS OF VARIOUS FUNCTIONS IN AN ORIGINAL WAY.

IT INCORNICIATO DA PARETI CONTINUE DI ARMADI COVER, LO SPAZIO GUARDAROBA PRESENTA AL CENTRO UNA COMPOSIZIONE ZENIT, QUI NELLA VERSIONE CABINA ARMADIO. LA LUMINOSITÀ DELLA SIMILPELLE ARENA DELLE ANTE DI COVER FA COSÌ DA SFONDO AL RIGORE DELL'ALLUMINIO IN FINITURA BRONZO DI ZENIT, MENTRE LE ATTREZZATURE DI QUEST'ULTIMA, AGGIORNATE RISPETTO ALLA PIÙ RECENTE VERSIONE, RISOLVONO CON ORIGINALITÀ LE TIPICHE ESIGENZE DI ORGANIZZAZIONE DELLE DIVERSE FUNZIONI.



EN The Zenit walk-in closet expands its design potential with the introduction of an exclusive range of modular drawer units, made with the latest production technologies for processing extruded and sheet aluminium. The drawers, coated inside with fabric or synthetic leather, are available in three widths, two heights and four aesthetic versions to meet highly personal demands concerning the organisation of walk-in closets: open drawer without front, drawer with glass front, drawer with lacquered front and drawer with synthetic leather front. The drawers, made of extruded aluminium, are characterised by their thin thickness of only 8 mm and the exclusive 'folding' processing without joints on the edges.

IT La cabina armadio Zenit amplia le proprie potenzialità progettuali con l'introduzione di un esclusivo programma di cassettiere modulari e componibili, realizzate con le più recenti tecnologie produttive per la lavorazione dell'alluminio estruso ed in lastra. I cassetti, rivestiti internamente in tessuto o similpelle, sono disponibili in tre larghezze, due altezze e in quattro versioni estetiche per rispondere alle esigenze più personali nell'organizzazione della cabina armadio; cassetto aperto senza frontale, cassetto con frontale in vetro, cassetto con frontale laccato e cassetto con frontale in similpelle. I cassetti, realizzati in alluminio estruso, sono caratterizzati dallo spessore sottile di soli 8 mm e dall'esclusiva lavorazione "folding" senza giunzioni sugli spigoli.

RU Потенциал гардеробной Zenit существенно расширяется за счет появления уникальной линейки комодов для хранения с ящиками, изготовленных с использованием новейших производственных технологий обработки экструдированного и листового алюминия. Ящики, полностью обтянутые тканью или синтетической кожей, предлагаются в трех вариантах ширины, двух вариантах высоты, а также четырех различных видах отделки, что позволяет удовлетворить самые разнообразные потребности в организации внутреннего пространства гардеробной. Среди вариантов исполнения фабрика предлагает открытый ящик без фронтальной панели, ящик со стеклянной фронтальной панелью, ящик с фронтальной панелью из окрашенного стекла или с отделкой синтетической кожей. Ящики, изготовленные из экструдированного алюминия, имеют толщину всего 8 мм, а применение уникальной технологии сгибания позволяет избежать стыков на углах.

汉语 Zenit步入式衣柜，以可组合且模块化抽屉柜的独特方案，扩展了自我的设计潜力，采用最新的挤压成型铝材和铝质片材生产技术制成。抽屉，完全以布料或合成皮覆面，可有三种宽度、两种高度以及四种美学版本的选项，可回应更个人化规划步入式衣柜的需求；开放式无正面面板的抽屉、玻璃正面面板抽屉、烤漆正面面板抽屉以及合成皮正面面板抽屉。抽屉，采用挤压成型铝材制成，不但以仅8mm的厚度展现独特，更采用独特「折叠」加工制作，获得了角边无缝的成果。



ZENIT  
struttura/structure: 303 bronzo  
rivestimento interno in similpelle/synthetic  
leather internal cladding: 157 arena  
top e frontale in vetro/glass top and drawer  
front: 63 grigio trasparente



ZENIT  
struttura/structure: 303 bronzo  
rivestimento interno in similpelle/synthetic  
leather internal cladding: 157 arena  
top e frontale in vetro/glass top and drawer  
front: 63 grigio trasparente

COVER FREESTANDING  
struttura/structure: 303 bronzo  
ante e accessori/doors and accessories:  
157 similpelle arena

EN The Cover closing system, also in the Freestanding version, continues its stylistic evolution which is all about lightness and formal linearity. The new hinged door is equipped with horizontal aluminium crosspieces that punctuate the wardrobe, enhancing the coating. A modular and always tailor-made solution, designed to organise spaces and create storage elements, compartments and equipped wardrobes that combine functional design and aesthetic refinement. All the doors are retro-finished with a lacquered aluminium panel matching the structure and equipped with magnetic closure.

IT Il sistema di chiusura Cover, anche nella versione Freestanding, prosegue la propria evoluzione stilistica all'insegna della leggerezza e della linearità formale. La nuova anta battente è dotata di traversi orizzontali in alluminio che ritmano l'armadiatura valorizzandone il rivestimento. Una soluzione componibile e sempre su misura, progettata per organizzare gli spazi, creando elementi contenitore, vani di passaggio e guardaroba attrezzati che associano design funzionale e ricercatezza estetica. Tutte le ante sono retrofinito con un pannello in alluminio laccato in tinta alla struttura e dotate di chiusura magnetica.

RU Система хранения Cover, как в классическом исполнении, так и в отдельно стоящей версии Freestanding, продолжает стилистически совершенствоваться, сохраняя свою неизменную легкость и четкость линий. Новые распашные двери оснащены горизонтальными траверсами из алюминия, подчеркивающими ритмичный рисунок всей композиции и оттеняющими изысканность отделки. Эта модульная система изготавливается по индивидуальным размерам и предназначена для грамотной организации пространства. Ее отличают функциональный дизайн и изысканность внешней отделки. Она может включать в себя модули для хранения, гардеробные модули с продуманным внутренним оснащением, а также предусматривает решения для оформления дверных проемов. С внутренней стороны все двери отделаны алюминиевыми панелями, окрашенными в цвет структуры, и оснащены магнитным замком.

汉语 Cover封闭系统, 也包含Freestanding版本, 延续着它轻盈与线性形式的风格演变。新款平开式柜门配备了铝质横梁, 在赋予整体柜门律动的同时, 也凸显覆面面料的质感。是一套模块组合并始终依据尺寸需求设计的解决方案, 无论用于规划空间或创造收纳元素、走道空间与配备齐全的收纳柜, 都是结合功能设计与精致美感的绝佳选择。所有门板的背面皆以烤漆铝质面板覆面, 烤漆的颜色与结构相同, 柜门配备磁性锁。

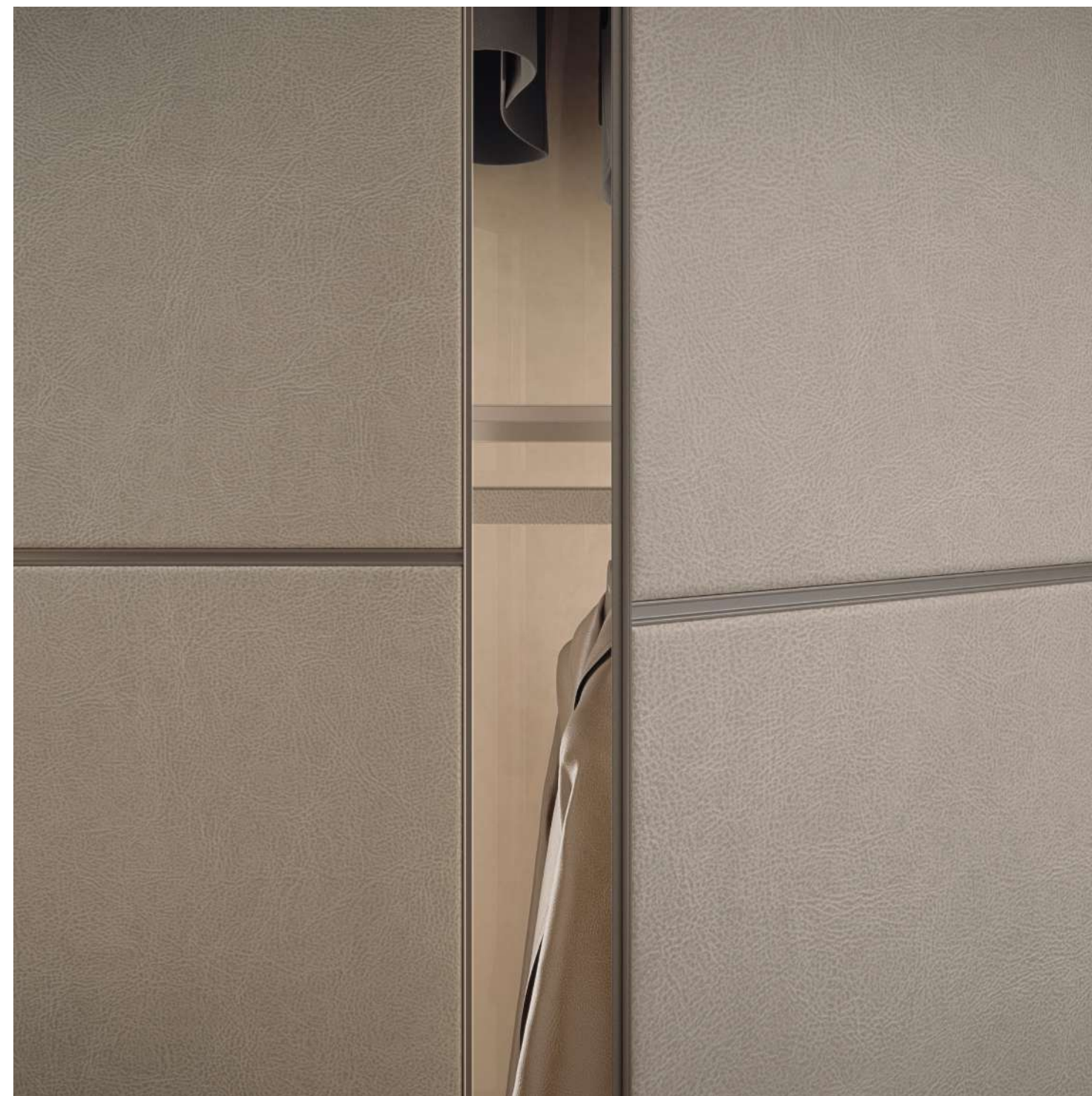

COVER FREESTANDING  
struttura/structure: 303 bronzo  
porte e accessori in similpelle/synthetic  
leather doors and accessories: 157 arena

# TECHNICAL DATA

## TAIGA, NEW FINISHING

EN The exclusive range of Rimadesio materials is being enriched with two new essences: oak and stained ebony, both available in the brand new taiga finish. The surface is marked by a finely striped horizontal texture, obtained through an innovative mechanical pressing process that gives the material a three-dimensional relief, soft to the touch. With its rigorous and elegant geometry, the taiga finish is able to enhance both the light shades of the oak and the dark tones of the stained ebony essence.

IT L'esclusiva gamma di materiali Rimadesio si arricchisce di due nuove essenze: rovere e tinto ebano, entrambe disponibili nell'inedita finitura taiga. La superficie è scandita da una texture orizzontale finemente rigata, ottenuta mediante un innovativo processo di pressatura meccanica che dona alla materia un rilievo tridimensionale, morbido al tatto. Con la sua geometria rigorosa ed elegante, la finitura taiga è in grado di valorizzare sia le sfumature chiare del rovere sia i toni scuri dell'essenza tinto ebano.

RU Эксклюзивная коллекция материалов Rimadesio пополнилась двумя вариантами шпона: это дуб натуральный и тонированный под эбеновое дерево, оба они доступны в новейшей отделке taiga. Поверхность имеет утонченную горизонтальную текстуру, такой эффект достигается с помощью механического прессования, придающего материалу трехмерный рельеф, мягкий на ощупь. Благодаря строгой и элегантной геометрии отделка taiga способна подчеркнуть как светлые оттенки дуба, так и темные тона шпона цвета эбенового дерева.

汉语 Rimadesio的独特材料系列新增了两款木质：橡木与染色黑檀木，两种木质皆可选Taiga饰面。表面带有横向细纹纹理，通过创新的机械式磨削加工流程制成，使材料获得立体的浮雕饰纹，柔和的触感。通过严谨与优雅的几何形态，Taiga饰面不但有能力凸显浅色调橡木的层次，也能展现深色调黑檀木的精髓。

EN In both rovere and tinto ebano wood, the new taiga finishing is available for several products in the collection: Link+, Aura, Moon, Luxor, Self, Wind, Opus, Zenit, Cover, Modulor and Radius.

IT In entrambe le essenze, rovere e tinto ebano, la nuova finitura taiga è disponibile per diversi prodotti della collezione: Link+, Aura, Moon, Luxor, Self, Wind, Opus, Zenit, Cover, Modulor e Radius.

RU Оба варианта шпона, дуб натуральный и тонированный под эбенное дерево, предлагаются в новейшей отделке taiga, которая доступна для различных изделий из коллекции фабрики: Link+, Aura, Moon, Luxor, Self, Wind, Opus, Zenit, Cover, Modulor и Radius.

双语 橡木与染色黑檀木两种木质的新饰面Taiga, 可运用于系列中多款产品: Link+, Aura, Moon, Luxor, Self, Wind, Opus, Zenit, Cover, Modulor与Radius。



701 rovere taiga



700 tinto ebano taiga

# RADIUS

EN Radius is the new bi-directional pivot door system designed by Giuseppe Bavuso. An innovative proposal in the Rimadesio's design process is the gradual elimination of structural elements, such as jambs and frames, to create solutions that can fit into environments maximising the superior qualities of an exclusive material such as aluminium. A full-height solution that is perfectly double-sided and coplanar to the wall, with a minimal design intended to blend harmoniously with the surrounding architecture.

IT Radius è il nuovo sistema di porte a bilico bidirezionale disegnato da Giuseppe Bavuso. Una proposta innovativa nel percorso progettuale Rimadesio: la progressiva eliminazione degli elementi strutturali, come stipiti e telai, per creare proposte che si possano inserire negli ambienti valorizzando al massimo le qualità superiori di un materiale esclusivo come l'alluminio. Una soluzione a tutta altezza perfettamente bifacciale e complanare alla parete, dal design minimale concepito per ricreare una perfetta continuità con l'architettura circostante.

RU Radius - это новая система бескоробочных дверей со скрытыми креплениями в пол и в потолок и двунаправленным открыванием, разработанная Джузеппе Бавузо. Это еще одно инновационное решение на уникальном творческом пути Rimadesio: постепенный отказ от привычных структурных элементов, таких, как дверные коробки и фальш-короба, и переход к новым решениям, дополняющим интерьер и подчеркивающим все достоинства такого уникального материала, как алюминий. Дверное полотно от пола до потолка, двусторонняя отделка, установка заподлицо со стеновыми панелями и минималистский дизайн этой двери позволяют выдержать весь интерьер в едином стиле, не нарушая его архитектурную композицию.

汉语 Radius是双向开枢轴门新系统,由Giuseppe Bavuso设计。是Rimadesio设计途径中的一项创新提案:逐渐移除如门框与框架等结构性元素,从而创作可轻易融入环境,又能凸显如铝材等高品质独特材料的作品。是一种完美双面并与墙面齐平的全高度解决方案,其极简风格的美感,专为能与周围的建筑创造完美连续性所设计。



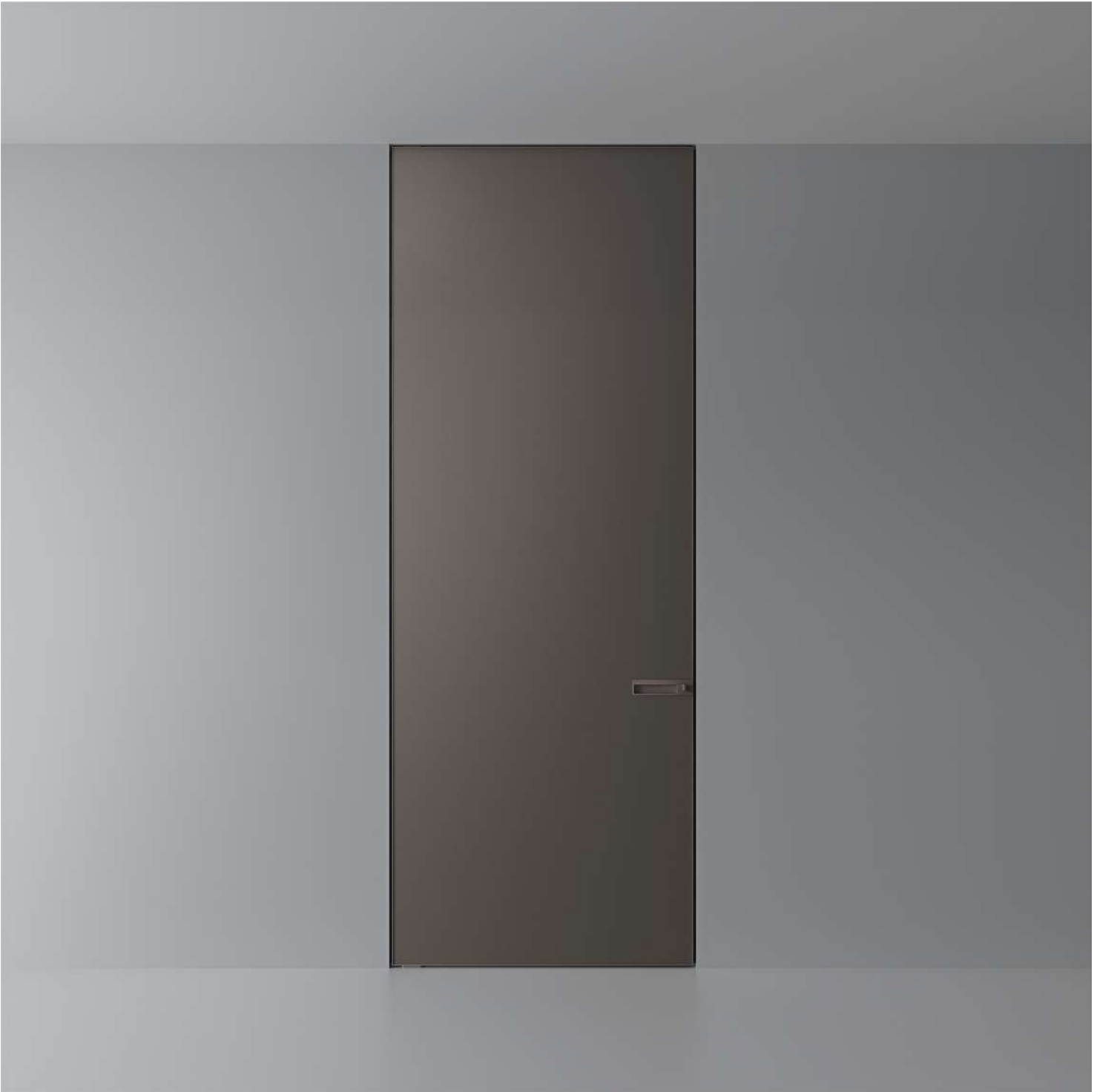

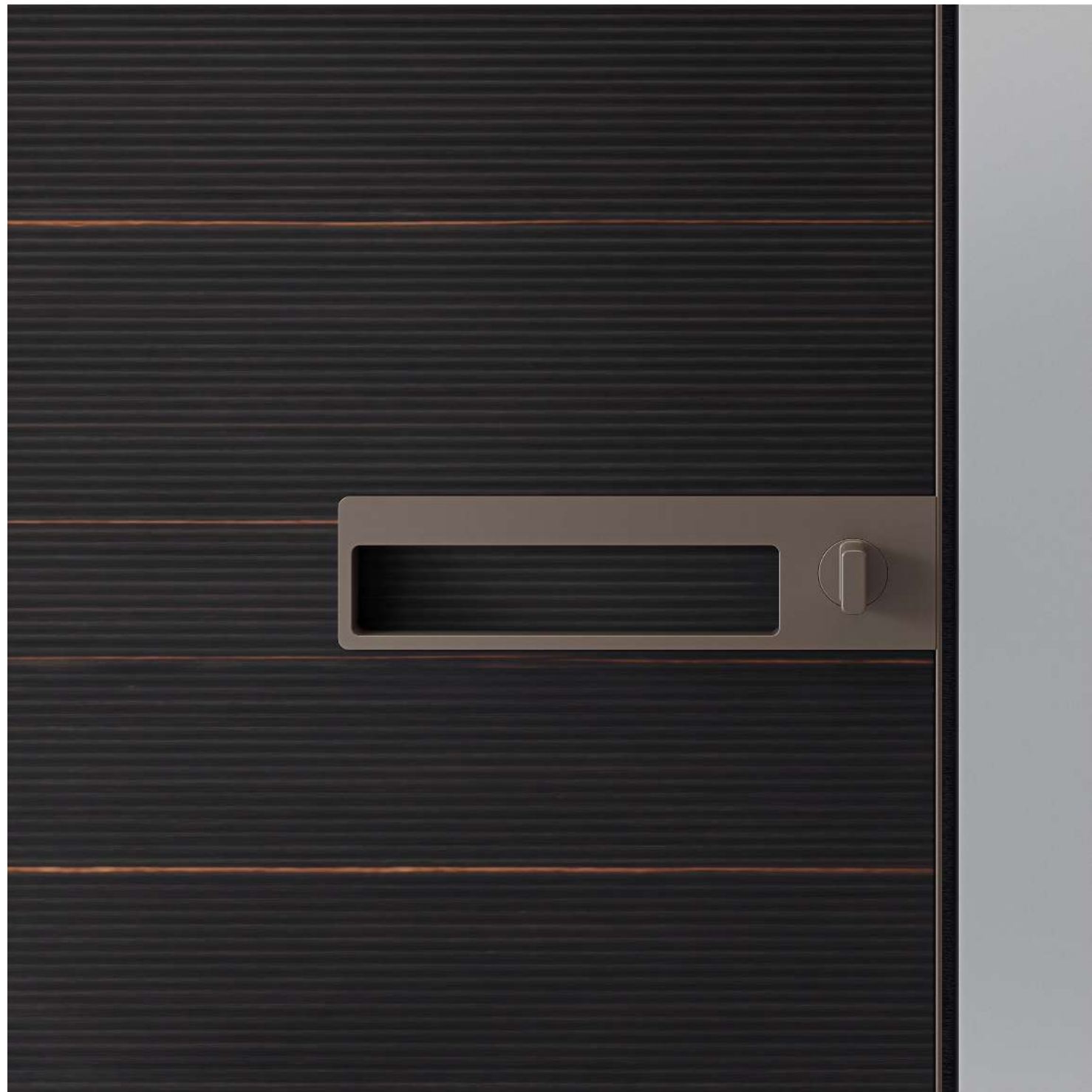



RADIUS  
porta con traversini orizzontali/  
door with horizontal crosspieces  
struttura/structure: 303 bronzo  
pannello porta/door panel: G002 moka

Porta singola  
Single door

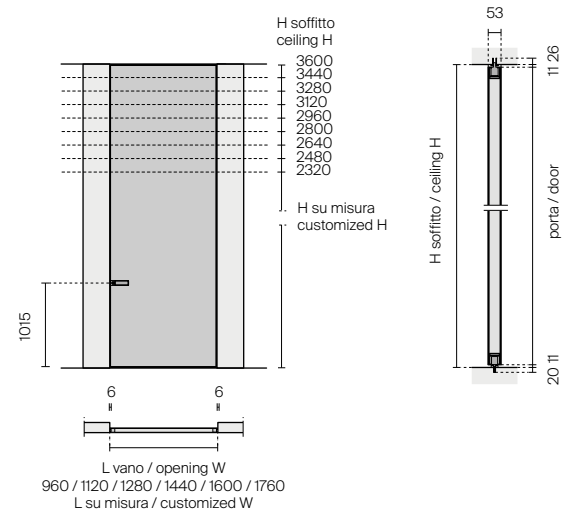

Porta doppia  
Double door

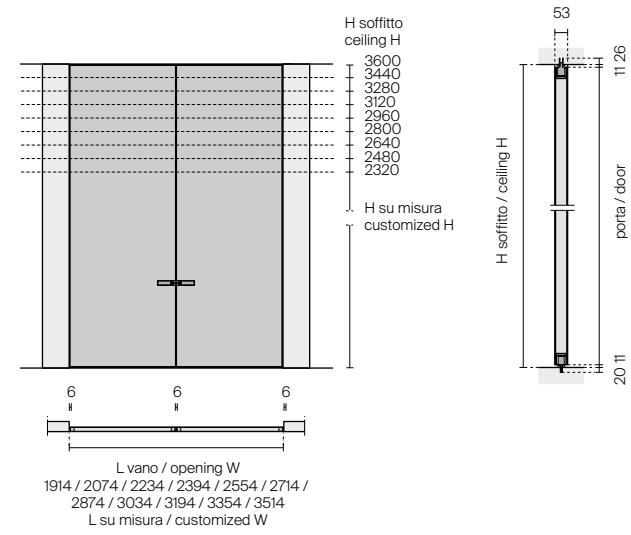

Porta bidirezionale senza stipite  
Bi-directional door without jamb

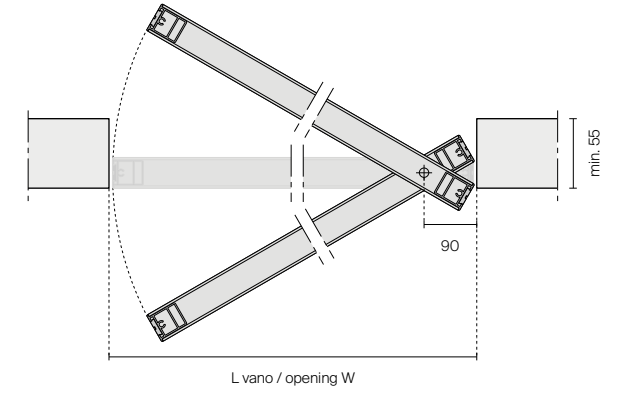
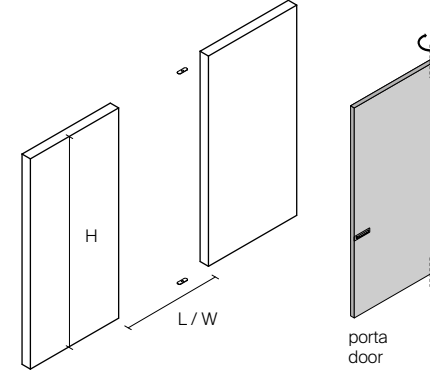

Porta bidirezionale con stipite e profilo di chiusura magnetico  
Bi-directional door with jamb and magnetic locking profile

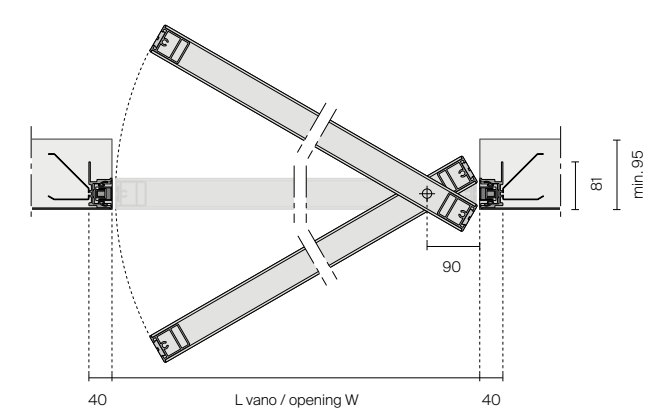
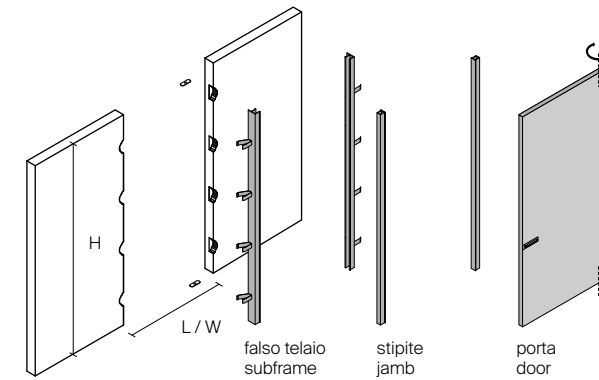

Porta bi-direzionale abbinata a boiserie modulare  
Bi-directional door combined with Modular panelling

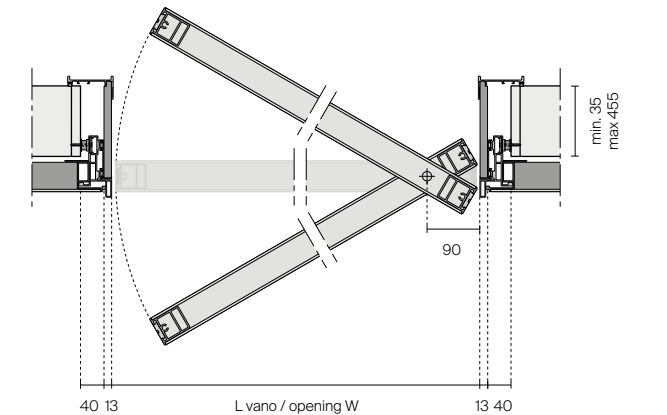
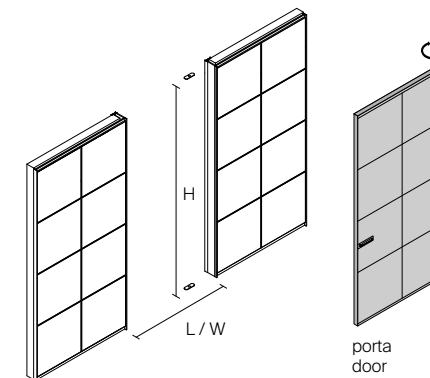

DESCRIZIONE TECNICA  
TECHNICAL DESCRIPTION

EN Always made to measure in height and width, Radius can be applied to large dimensions, with panels reaching 3600 mm in height and 1760 mm in width. It is also available in a double leaf version. The product's versatility allows installation on the wall without a jamb, with a concealed jamb equipped with a magnetic closing profile, or integrated into the Modular boiserie system.

IT Realizzata sempre su misura in altezza e larghezza, Radius è capace di declinarsi su grandi dimensioni, con pannelli che raggiungono 3600 mm in altezza e 1760 mm in larghezza. E' disponibile anche nella versione a doppio battente. La versatilità del prodotto permette l'installazione su parete senza stipite, con stipite a scomparsa dotato di profilo di chiusura magnetico, oppure integrata nella boiserie Modular.

RU Дверь Radius изготавливается по индивидуальным размерам по высоте и ширине, дверное полотно может достигать 3600 мм в высоту и 1760 мм в ширину. Эта модель также доступна в исполнении с двумя распашными дверными полотнами. Универсальность модели позволяет устанавливать ее к стенам без дверной коробки или с фальш-коробом, оснащенным магнитной планкой, а также встраивать эту дверь в стеновую перегородку Modular.

汉语 高度与宽度的尺寸始终量身定制, Radius具有适应大型尺寸的能力, 面板可达最高3600mm, 最宽1760mm。也推出双向平开的版本。这产品的通用特性获得了无须在墙上安装门框的优势, 可配备带磁性闭合边框的隐藏式门框, 或者可与Modular装饰镶板整合于一体。

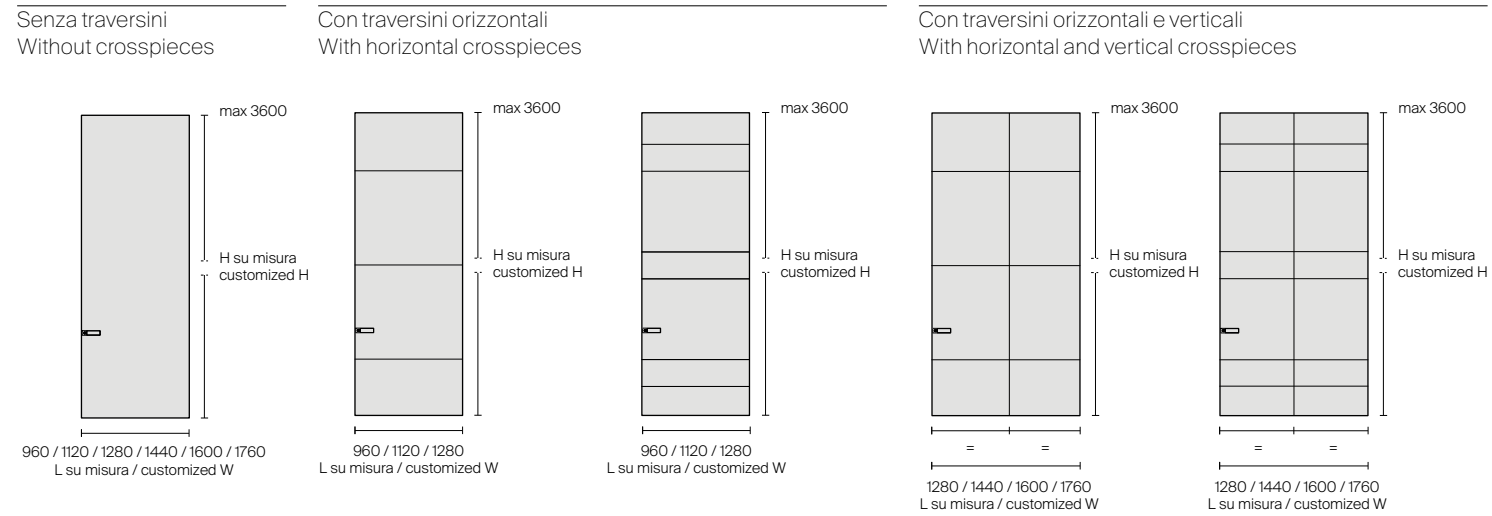

EN The panel is available with full-length mirror or with decorative horizontal and vertical crosspieces. The aluminium frame of Radius is available in aluminium, brown and 46 Ecolorsystem finishings. The double-sided door panel cladding is available in glossy, mat, reflex, sahara, diamante and mirror lacquered glass or in Litech, sahara and taiga essence, fabric or synthetic leather, for a total of 161 finishings.

IT Il pannello è disponibile a specchiatura intera o con traversi decorativi orizzontali e verticali. La struttura in alluminio di Radius è disponibile in finitura alluminio, brown e nelle 46 varianti ecolorsystem. Il rivestimento bifacciale del pannello porta è disponibile in vetro laccato lucido, opaco, reflex, sahara, diamante, specchio oppure in Litech, sahara e taiga, in tessuto o similpelle, per un totale di 161 finiture.

RU Дверное полотно может быть как сплошное, так и в версии с горизонтальными и вертикальными декоративными профилями. Алюминиевая конструкция двери Radius доступна в отделке алюминий, brown, а также в 46 цветах палитры Ecolorsystem. Дверное полотно имеет двустороннюю отделку и предлагается в отделке из матового или глянцевого окрашенного стекла, зеркального стекла reflex, стекла с волнистой поверхностью sahara, мерцающего стекла diamante, зеркала или эксклюзивного материала Litech. Также доступна облицовка шпоном с волнистой поверхностью sahara или с рифленой поверхностью taiga, обшивка тканью или синтетической кожей: в общей сложности для данной модели предлагается 161 уникальная отделка.

汉语 面板推出全镜面或带横向与竖向装饰梁的版本。Radius铝质结构的饰面可选铝色、棕色以及46种Ecolorsystem色彩。双面门板的面板饰面可选：烤漆玻璃——亮光、哑光、反光、sahara、水晶、镜面；Litech陶瓷；木质——sahara与三taiga；布料或合成皮等共161种饰面。

Struttura e maniglia  
Structure and handle

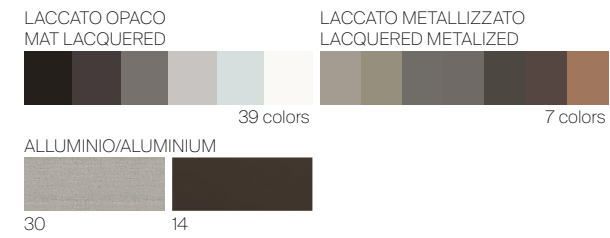

Pannello porta  
Door panel

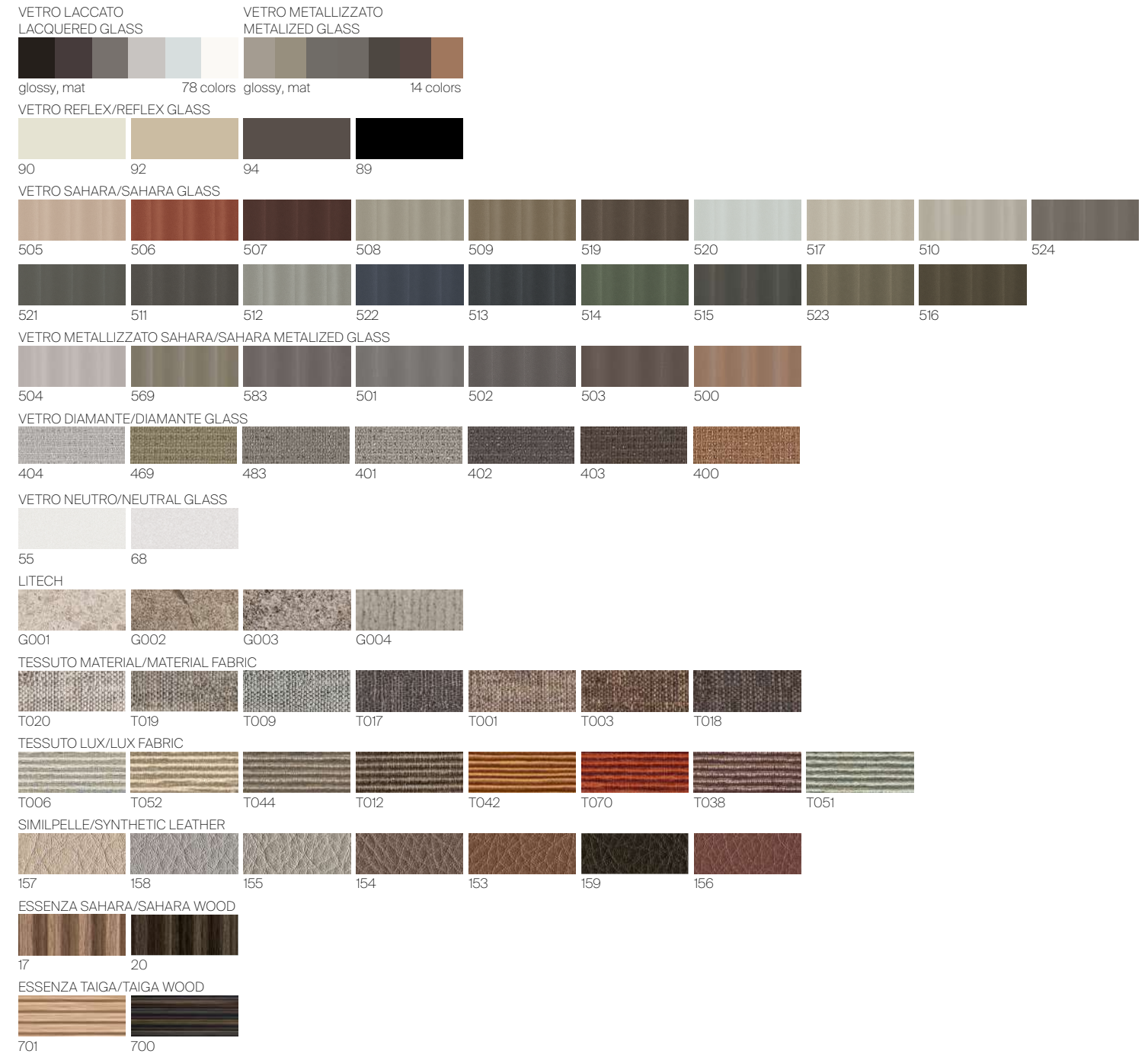

## SELF

EN New aesthetics and new solutions for Self, the sideboard system that is now a classic in the Rimadesio collection. The protagonist of the new compositions is the unprecedented taiga finishing proposed in two different essences: rovere and tinto ebano. The surface is marked by a finely striped horizontal texture, obtained by a mechanical pressing process that gives the material a three-dimensional relief, soft to the touch.

IT Nuova estetica e nuove soluzioni per Self, il sistema di madie che rappresenta ormai un classico della collezione Rimadesio. Protagonista delle nuove composizioni l'inedita finitura taiga proposta in due diverse essenze: rovere e tinto ebano. La superficie è scandita da una texture orizzontale finemente rigata, ottenuta con un processo di pressatura meccanica che dona alla materia un rilievo tridimensionale, morbido al tatto.

RU Представляем новый облик и новые композиционные решения для Self, системы модулей хранения, ставшей настоящей классикой в коллекции Rimadesio. Главный акцент в новых композициях сделан на уникальной отделке taiga, предлагаемой для двух новых вариантов шпона дуба: натурального и тонированного под эбеновое дерево. Поверхности с такой отделкой имеют текстуру с мельчайшим рифлением по всей площади, подобный эффект достигается с помощью механического прессования, придающего материалу трехмерный рельеф, мягкий на ощупь.

汉语 新美感与新解决方案的Self边柜系统, 已成为象征Rimadesio系列的经典品项。新款样式的主角是前所未有的taiga饰面: 推出橡木与染色黑檀木两种新木质。表面带有横向细纹纹理, 通过机械式磨削加工制成, 使材料获得立体的浮雕饰纹, 柔和的触感。





SELF  
struttura/structure: 303 bronzo  
frontali/fronts: 700 tinto ebano taiga  
top in marmo/marble top: 183 noir saint laurent





SELF  
struttura/structure: 303 bronzo  
frontali/fronts: 700 tinto ebano taiga  
top in marmo/marble top: 183 noir saint laurent

# ZENIT BOOKCASE

EN In the bookcase version, Zenit has even greater design potential with the introduction of a brand new backlighted upright and a new suspended containers which, like all Zenit compositional elements, allow for free positioning. The range includes a chest of drawers, a container with doors, a chest of drawers with a flap door and drawer and a container with a flap door. The new aluminum drawers, with fully extractable runners, are equipped with an unprecedented push opening system and cushioned return.

IT Nella versione libreria Zenit amplia le proprie potenzialità progettuali con l'introduzione di un inedito montante retroilluminato e di nuovi contenitori sospesi che, come tutti gli elementi compositivi di Zenit, consentono un libero posizionamento. La gamma comprende: cassettera, contenitore con ante, cassettera con anta ribalta e cassetto, contenitore con anta ribalta. I nuovi cassetti in alluminio, con guide ad estrazione totale, sono dotati di un inedito sistema di apertura push e rientro ammortizzato.

RU Библиотека Zenit сегодня дарит новые возможности для проектирования с появлением новой стойки с подсветкой и новых подвесных модулей хранения, которые, как и все элементы системы Zenit, размещаются произвольно, в любом желаемом месте. Линейка включает в себя: комод, модуль с распашными дверцами, модуль с откидной дверью и выдвижной ящик. Новые алюминиевые ящики с направляющими, допускающими полное выдвижение ящика, и оснащенными новейшей системой открывания push и плавного закрывания.

汉语 书架版本的Zenit, 有了扩增设计潜力的新元素, 如前所未有的背光支撑架与新款悬挂式收纳柜。也如同Zenit其他组合元素般, 皆可自由地摆放配置。新组件包括有: 抽屉柜、带柜门收纳柜、带掀式柜门的抽屉柜与抽屉, 带掀式柜门的收纳柜。新款铝质抽屉, 带导轨并可完全抽出, 并配备全新的按压式开启以及缓冲阻尼关闭系统。

Contenitore con cassetti  
Suspended unit with drawers



Contenitore con ante battenti  
Suspended unit with hinged doors



Contenitore con un cassetto e un'anta a ribalta  
Suspended unit with drawer and flap door



Contenitore con cassetto  
Suspended unit with drawer



Zenit libreria  
Zenit bookcase

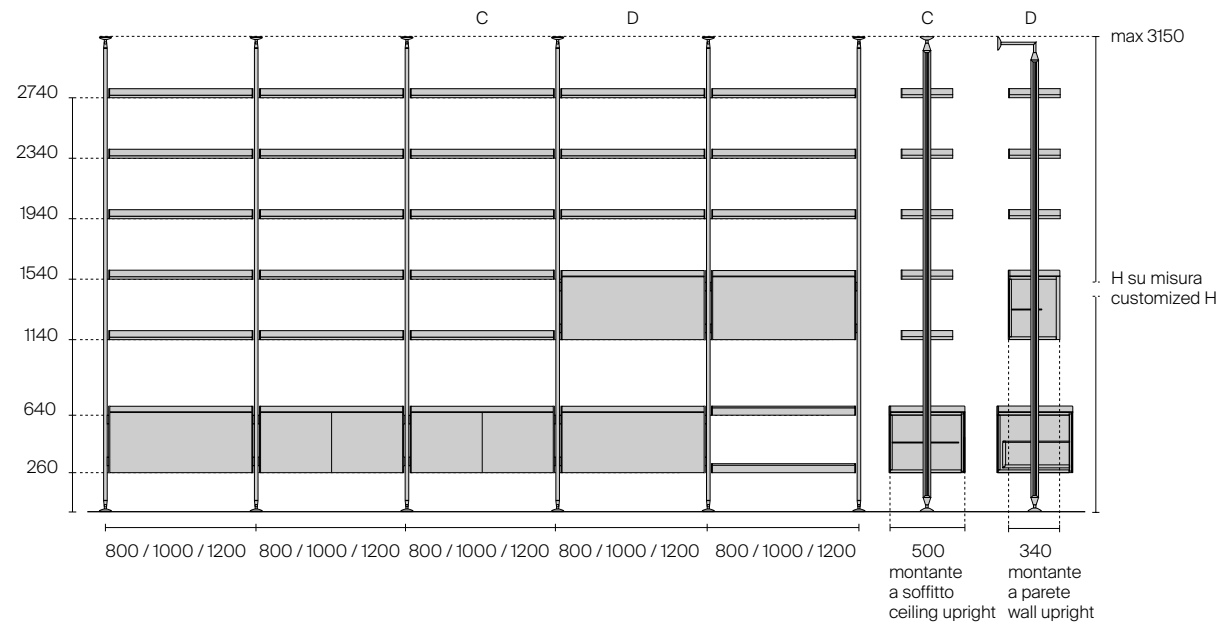
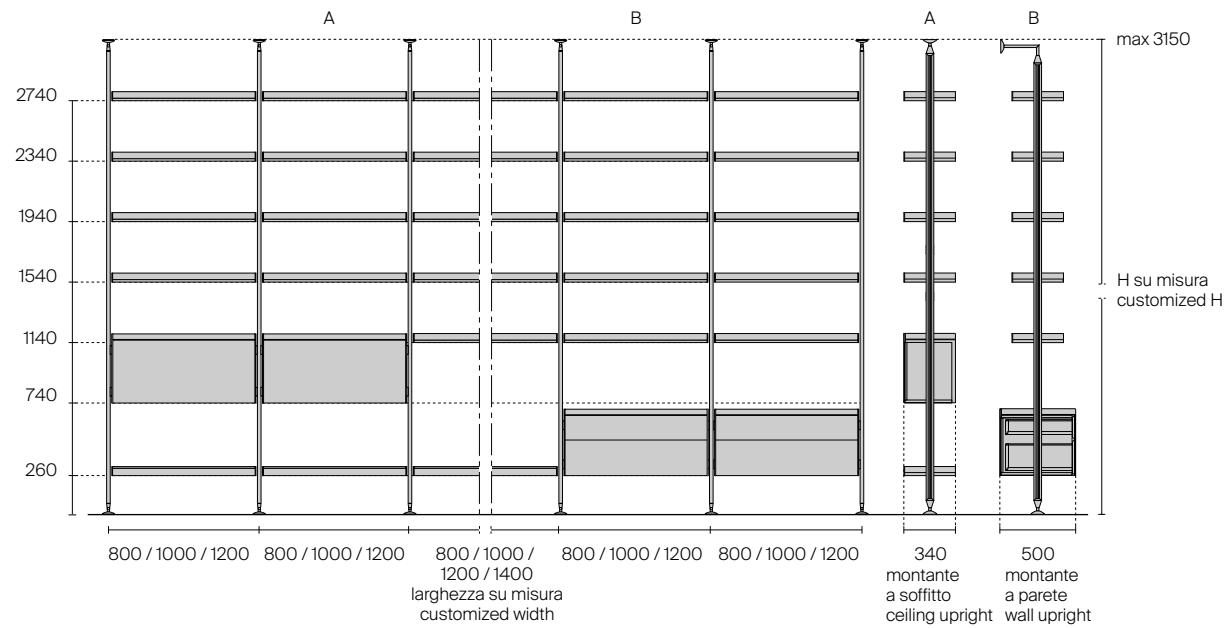

MONTANTI  
UPRIGHTS

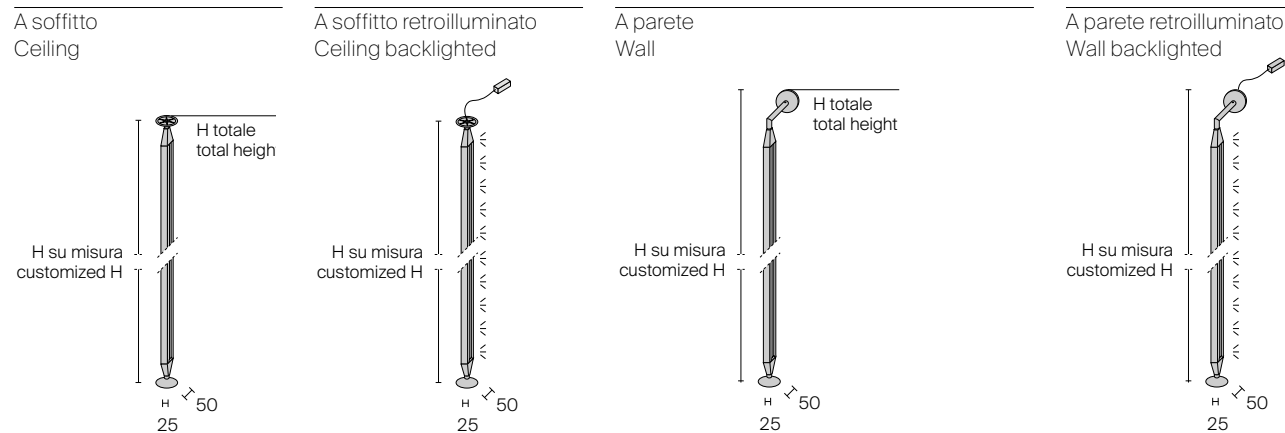

Contenitore con cassetti P 500  
Suspended unit with drawers D 500

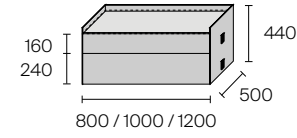

Contenitore con un cassetto e un'anta a ribalta P 500  
Suspended unit with drawer and flap door D 500

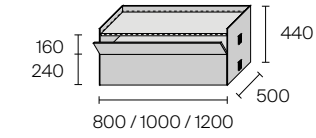

Contenitore con cassetto P 500  
Suspended unit with drawer D 500

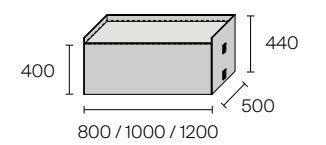

Contenitore con ante battenti P 500  
Suspended unit with hinged doors D 500

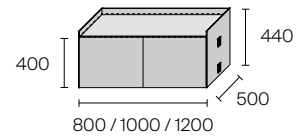

Contenitore con anta a ribalta P 340  
Suspended unit with flap door D 340  
fianco alto/high side

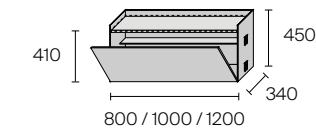

Contenitore con anta a ribalta P 340  
Suspended unit with flap door D 340  
fianco basso/low side

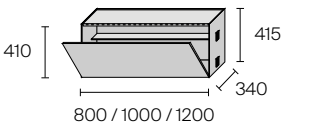

Top di finitura in vetro spessore 4mm  
Finishing top in glass thickness 4mm

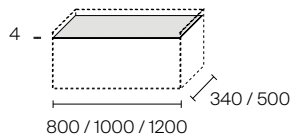

Top di finitura in Litech spessore 4mm  
Finishing top in Litech thickness 4mm

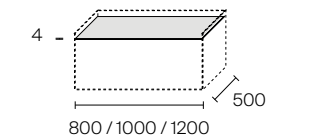

Top di finitura in marmo spessore 20mm  
Finishing top in marble thickness 20mm

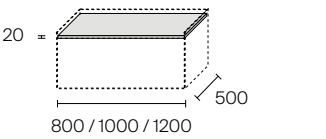

Ripiano in vetro opzionale  
Optional glass shelf  
Disponibile per contenitore con ante battenti  
Available for container with hinged doors

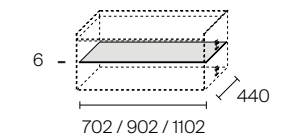

Mensola in vetro rivestita in similpelle  
Glass shelf covered with synthetic leather

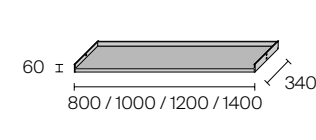

Passacavo opzionale per contenitori profondità 500  
Optional cable duct for units depth 500

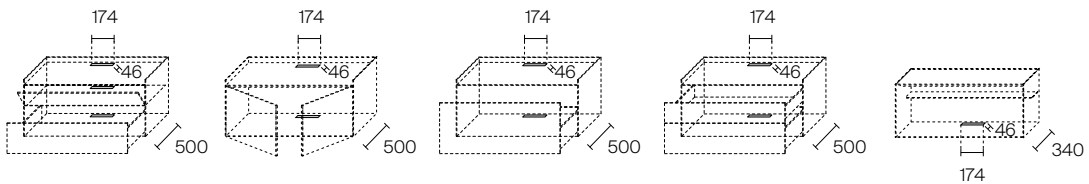

Passacavo interno opzionale per contenitori profondità 340  
Optional internal cable duct for units depth 340

non disponibile per contenitori con top in marmo / not available for units with marble top

Illuminazione interna opzionale per contenitori  
Optional internal lighting

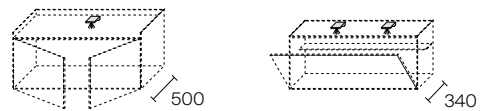

Alimentatore elettronico per presa comandata o per sistema Dali o per telecomando  
Electronic control gear for power switch or Dali system control gear or electronic control gear for remote control device

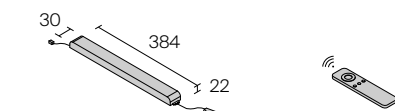

## ZENIT WALK-IN CLOSET

EN The Zenit walk-in closet increases its design potential with the introduction of new freely positionable suspended drawer units. The drawers are internally lined with fabric or synthetic leather and they are available in two heights and four aesthetic versions: open drawer without front, drawer with glass front, drawer with synthetic leather front, drawer with lacquered front. Also for the walk-in closet version, the new backlighted upright is available.

IT La cabina armadio Zenit amplia le proprie potenzialità progettuali con l'introduzione di nuove cassettiere sospese liberamente posizionabili. I cassetti sono rivestiti internamente in tessuto o similpelle e sono disponibili in due altezze e in quattro versioni estetiche: cassetto aperto senza frontale, cassetto con frontale in vetro, cassetto con frontale in similpelle, cassetto con frontale laccato. Anche per la versione cabina armadio, è previsto il nuovo montante retroilluminato.

RU Дизайнерский потенциал гардеробной Zenit существенно расширяется за счет появления уникальной линейки модулей для хранения с ящиками, которые можно разместить в любом желаемом месте. Ящики, полностью обтянутые тканью или синтетической кожей, предлагаются в трех вариантах ширины, двух вариантах высоты, а также четырех различных видах отделки: открытый ящик без передней панели, ящик со стеклянной передней панелью, ящик с передней панелью из кожзаменителя, ящик с окрашенной передней панелью. Также для гардеробной предусмотрена новая стойка со встроенной подсветкой.

汉语 Zenit步入式衣柜, 通过可自由摆放配置的悬挂式抽屉柜, 扩展了自我的设计潜力。抽屉完全以布料或合成皮覆面, 可有两种高度以及四种美学版本的选项: 开放式无正面面板的抽屉、玻璃正面面板抽屉、合成皮正面面板抽屉以及烤漆正面面板抽屉。同样的在步入式衣柜的版本中, 也可选用带背光照明的支撑结构。



ZENIT  
struttura/structure: 303 bronzo  
rivestimento interno in similpelle/synthetic leather  
internal cladding: 157 arena  
top e frontale in vetro/top and glass front: 63 grigio  
trasparente

Zenit cabina armadio  
Zenit walk-in closet

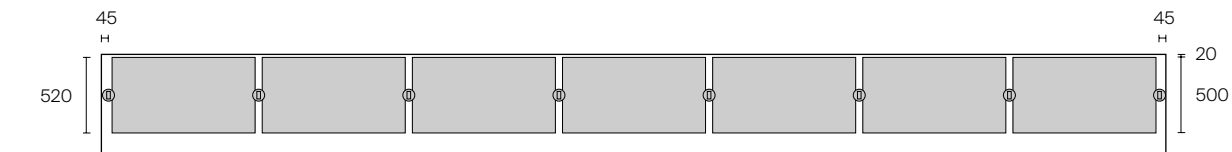
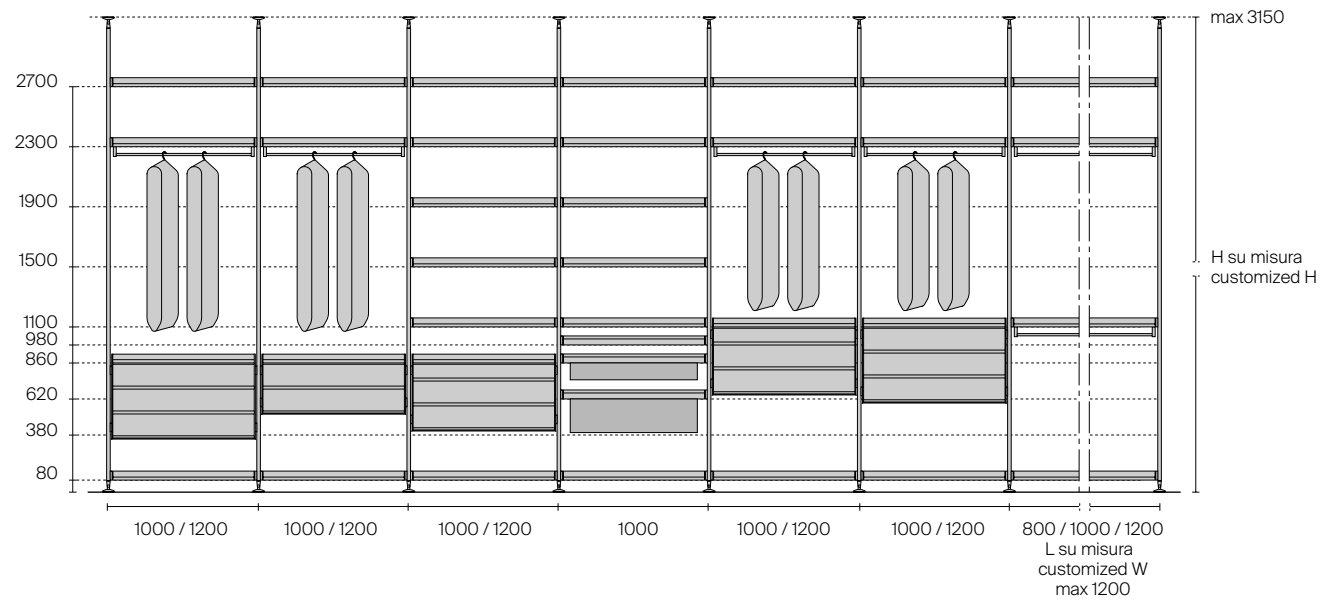

MONTANTI  
UPRIGHTS

A soffitto Ceiling  
A soffitto retroilluminato Ceiling backlighted  
A parete Wall  
A parete retroilluminato Wall backlighted

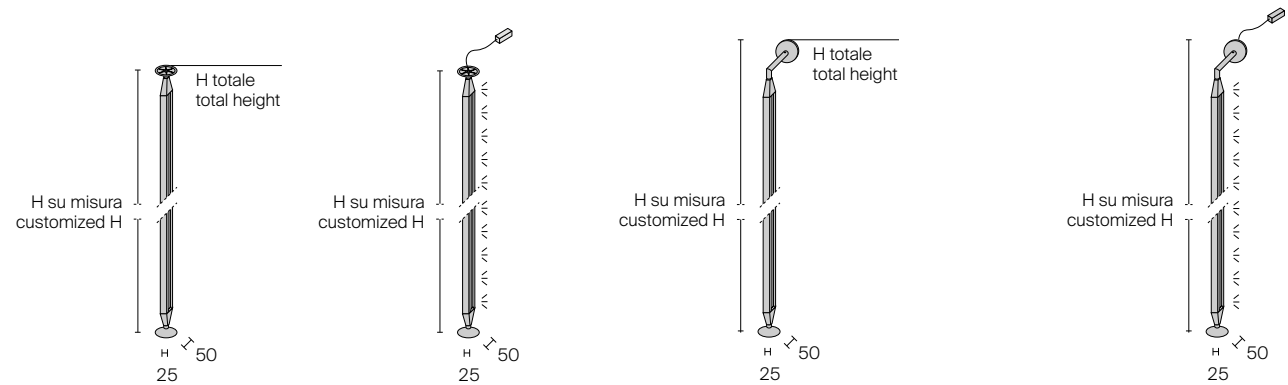

COMPONENTI  
COMPONENTS

Alimentatore elettronico per presa comandata o per sistema Dali o per telecomando  
Electronic control gear for power switch or Dali system control gear or electronic control gear for remote control device

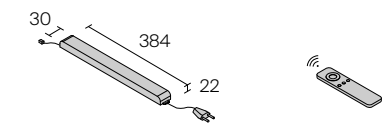

Mensola rivestita in similpelle  
Shelf covered with synthetic leather

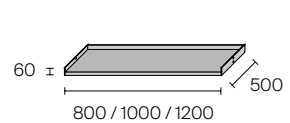

Mensola angolare rivestita in similpelle  
Corner shelf covered with synthetic leather

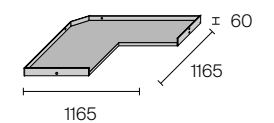

Mensola portascarpe rivestita in similpelle  
Shoe shelf covered with synthetic leather

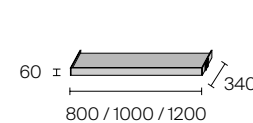

H 400 CON DUE CASSETTI/WITH TWO DRAWERS

2 frontali laccati  
2 lacquered fronts

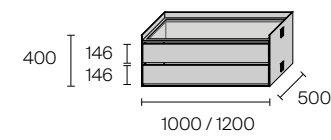

2 frontali vetro  
2 glass fronts

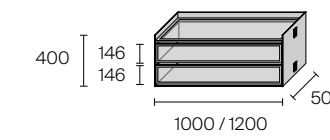

2 frontali similpelle  
2 synthetic leather fronts

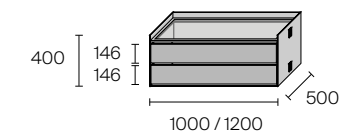

1 frontale vetro, 1 frontale laccato  
1 glass front, 1 lacquered front

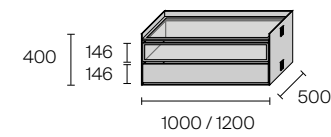

1 frontale vetro, 1 cassetto aperto senza frontale  
1 glass front, 1 open drawer without front

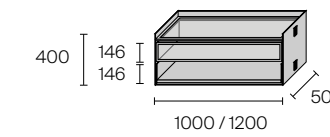

2 cassetti aperti senza frontale  
2 open drawers without front

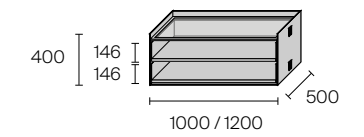

H 515 CON TRE CASSETTI/WITH THREE DRAWERS

3 frontali laccati  
3 lacquered fronts

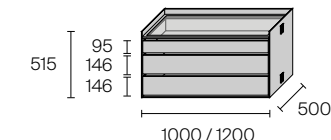

3 frontali vetro  
3 glass fronts

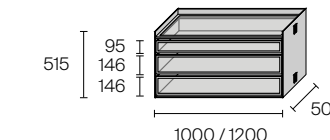

3 frontali similpelle  
3 synthetic leather fronts

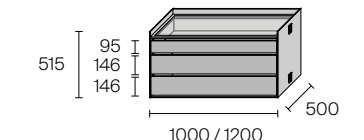

1 frontale vetro, 2 frontali laccati  
1 glass front, 2 with lacquered fronts

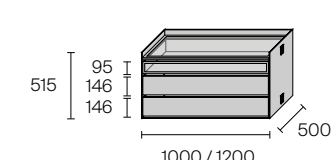

1 frontale vetro, 2 cassetti aperti senza frontale  
1 glass front, 2 open drawers without front

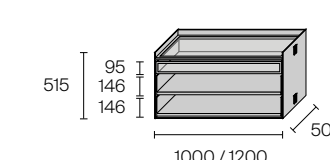

H 566 CON TRE CASSETTI/WITH THREE DRAWERS

3 frontali laccati  
3 lacquered fronts

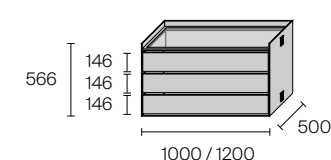

3 frontali vetro  
3 glass fronts

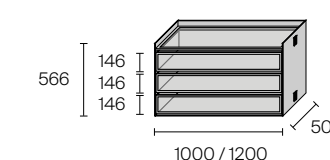

3 frontali similpelle  
3 synthetic leather fronts

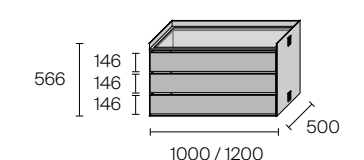

1 frontale vetro, 2 frontali laccati  
1 glass front, 2 with lacquered fronts

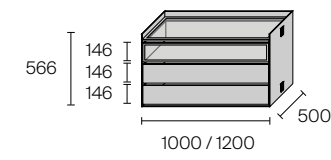

1 frontale vetro, 2 cassetti aperti senza frontale  
1 glass front, 2 open drawers without front

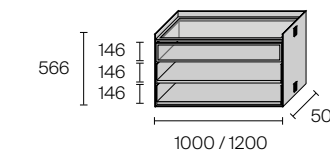

3 cassetti aperti senza frontale  
3 open drawers without front

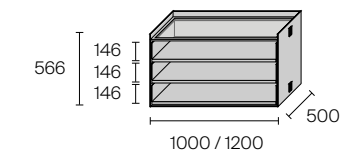

# COVER

EN The Cover project expands its design potential with the introduction of new suspended drawer units. The drawers are internally lined with fabric in 15 colour variants or synthetic leather in 7 colour variants and they are available in two heights and four aesthetic versions: open drawer without front, drawer with glass front, drawer with synthetic leather front, drawer with lacquered front.

IT Il progetto Cover amplia le proprie potenzialità progettuali con l'introduzione di nuove cassettiere sospese. I cassetti sono rivestiti internamente in tessuto in 15 varianti di colore o in similpelle in 7 varianti di colore e sono disponibili in due altezze e in quattro versioni estetiche: cassetto aperto senza frontale, cassetto con frontale in vetro, cassetto con frontale in similpelle, cassetto con frontale laccato.

RU При работе с моделью Cover возможности дизайнеров существенно возрастают за счет появления линейки подвесных комодов для хранения с ящиками. Внутренняя поверхность ящиков может быть отделана тканью, в одном из 15 различных цветов, или синтетической кожей, в одном из 7 цветов; ящики предлагаются в двух вариантах высоты, а также четырех различных вариантах исполнения: открытый ящик без передней панели, ящик со стеклянной передней панелью, ящик с передней панелью из кожзаменителя, ящик с окрашенной передней панелью.

汉语 Cover项目, 通过新款悬挂式抽屉柜, 扩展了自我的设计潜力。抽屉完全以布料或合成皮覆面, 布料共有15种颜色, 合成皮则有7种颜色。推出两种高度以及四种美学版本的选项: 开放式无正面面板的抽屉、玻璃正面面板抽屉、合成皮正面面板抽屉以及烤漆正面面板抽屉。



TIPOLOGIE ESTETICHE CASSETTIERE SOSPESA  
SUSPENDED DRAWER UNITS AESTHETICAL TYPOLOGIES

Top in vetro trasparente, 1 cassetto con frontale in vetro, 2 cassetti aperti senza frontale. Rivestimento interno cassetti in tessuto.  
Transparent glass top, 1 drawer with glass front, 2 open drawers without front. Fabric internal drawer cladding.



Top in vetro trasparente, 3 cassetti con frontale in vetro. Rivestimento interno cassetti in similpelle.  
Transparent glass top, 3 drawers with glass front. Synthetic leather internal drawer cladding.



Top in vetro trasparente, 1 cassetto con frontale in vetro, 2 cassetti con frontale laccato. Rivestimento interno cassetti in similpelle.  
Transparent glass top, 1 drawer with glass front, 2 drawers with laquered fronts. Synthetic leather internal drawer cladding.



Top in similpelle, 3 cassetti con frontale in similpelle. Rivestimento interno cassetti in similpelle.  
Synthetic leather top, 3 drawers with synthetic leather fronts. Synthetic leather internal drawer cladding.



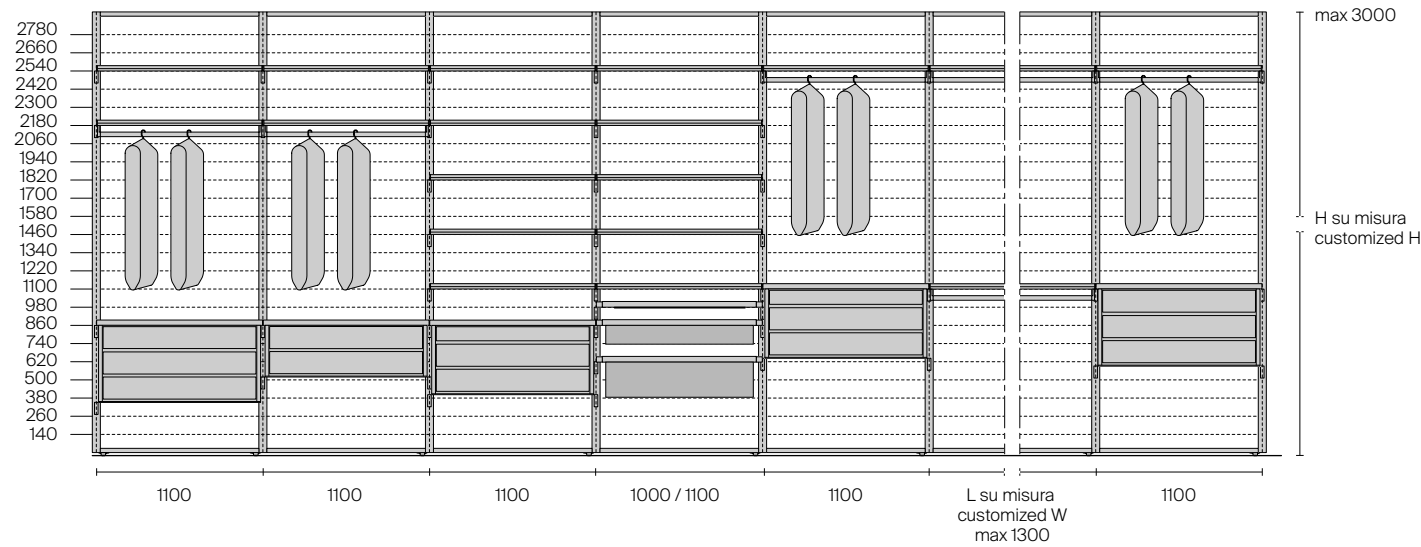

DESCRIZIONE TECNICA  
TECHNICAL DESCRIPTION

EN The Cover project is updated with a programme of modular and sectional drawer units, manufactured using the latest production technologies for processing extruded aluminium: the drawers are characterised by a thin thickness of only 8 mm and the exclusive 'folding' processing without joints on the edges.

IT Il progetto Cover si aggiorna con un programma di cassetiere modulari e componibili, realizzate con le più recenti tecnologie produttive per la lavorazione dell'alluminio estruso: i cassetti sono caratterizzati dallo spessore sottile di soli 8 mm e dall'esclusiva lavorazione "folding" senza giunzioni sugli spigoli.

RU Потенциал модели Cover многократно увеличивается за счет появления уникальной линейки комодов для хранения с ящиками, изготовленных с использованием новейших производственных технологий обработки экструдированного и листового алюминия. Ящики имеют толщину всего 8 мм, а применение уникальной технологии сгибания позволяет избежать стыков на уголках.

汉语 Cover项目通过可组合且模块化抽屉柜的独特方案进行更新,以最新的挤压成型铝材产技术制成:不但以仅8mm的厚度展现独特,更采用独特「折叠」加工制作,获得了角边无缝的成果。

H 378 CON DUE CASSETTI/WITH TWO DRAWERS

2 frontali laccati  
2 lacquered fronts

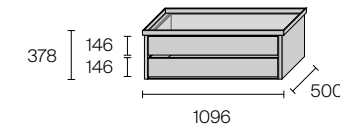

2 frontali vetro  
2 glass fronts

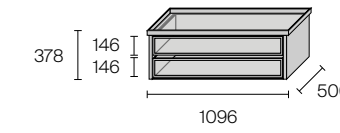

2 frontali similpelle  
2 synthetic leather fronts

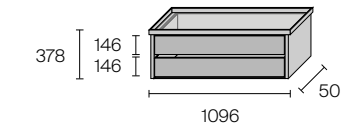

1 frontale vetro, 1 frontale laccato  
1 glass front, 1 lacquered front

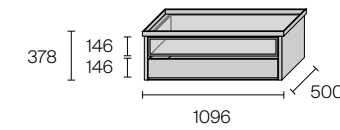

1 frontale vetro, 1 cassetto aperto senza frontale  
1 glass front, 1 open drawer without front

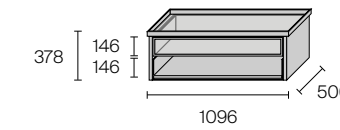

2 cassetti aperti senza frontale  
2 open drawers without front

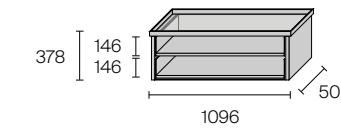

H 493 CON TRE CASSETTI/WITH THREE DRAWERS

3 frontali laccati  
3 lacquered fronts

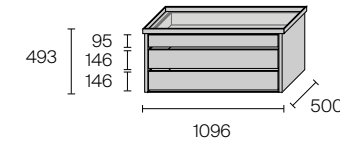

3 frontali vetro  
3 glass fronts

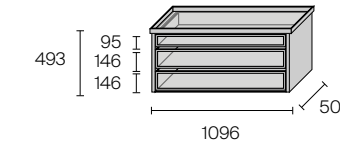

3 frontali similpelle  
3 synthetic leather fronts

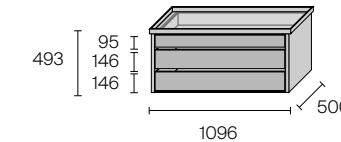

1 frontale vetro, 2 frontali laccati  
1 glass front, 2 with lacquered fronts

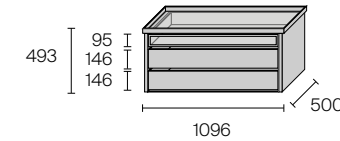

1 frontale vetro, 2 cassetti aperti senza frontale  
1 glass front, 2 open drawers without front

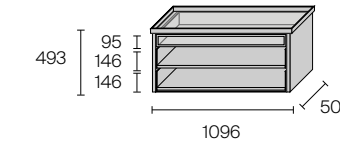

H 544 CON TRE CASSETTI/WITH THREE DRAWERS

3 frontali laccati  
3 lacquered fronts

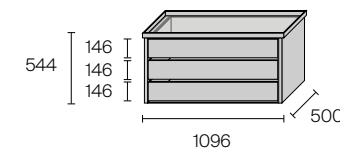

3 frontali vetro  
3 glass fronts

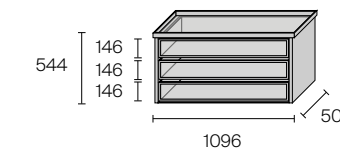

3 frontali similpelle  
3 synthetic leather fronts

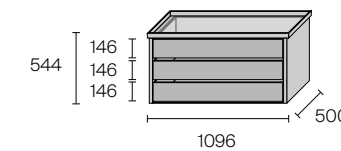

1 frontale vetro, 2 frontali laccati  
1 glass front, 2 with lacquered fronts

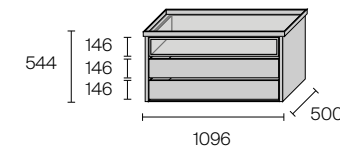

1 frontale vetro, 2 cassetti aperti senza frontale  
1 glass front, 2 open drawers without front

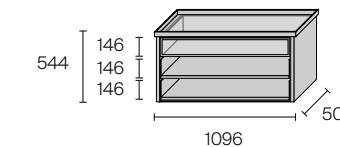

3 cassetti aperti senza frontale  
3 open drawers without front

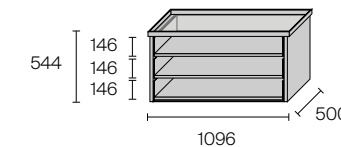

# ALIANTE

EN Aliante appears as a precious transparent glass cabinet with an original opening system. It is a cabinet with rigorous proportions, which concentrates a series of exclusive technical solutions. These include the special opening of the doors which, with a thin aluminium structure and a special glass assembly technique, exclude the presence of lateral flanks and give the container an extraordinary light and transparent image.

IT Aliante si presenta come uno scrigno prezioso in vetro trasparente, dotato di un inedito sistema di apertura. Un contenitore dalle proporzioni rigorose, che concentra una serie di soluzioni tecniche esclusive. Come la particolare apertura delle ante che, dotate di una sottile struttura in alluminio e di una speciale tecnica di assemblaggio del vetro, escludono la presenza di fianchi laterali e conferiscono al contenitore un'immagine straordinariamente leggera e trasparente.

RU Модель Aliante – это изысканный и утонченный модуль хранения из прозрачного стекла, оснащенный новейшей системой открывания. Он имеет строгие пропорции и воплощает в себе ряд эксклюзивных технологических решений. Одно из них – это оригинальное открывание распашных дверок, которые обрамлены тонкой алюминиевой рамкой по периметру. Кроме того, благодаря специальной технике установки стекла, модель не имеет внешних боковых стенок, что придает ей необычайную легкость и воздушность.

汉语 犹如珍宝柜以透明玻璃制成的Aliante, 配备了一套前所未有的开启系统。在这座比例严谨的收纳柜中, 浓缩了一系列专属技术的解决方案。特殊开启方式的柜门, 通过纤细的铝质结构、采用特别技术组装的玻璃以及排除侧板设计, 赋予了收纳柜一种非凡轻盈与透明的型态。



ALIANTE  
 struttura/structure: 303 bronzo  
 vetro/glass: 67 riflettente chiaro  
 ripiani interni in vetro/glass internal shelves:  
 63 grigio trasparente

basamento, top, cassetiera e schienale/  
 base, top, drawer unit and back panel: 15 noce  
 interno cassetti e top cassetiera in similpelle/  
 synthetic leather internal drawers and lower  
 top: 153 castoro



#### DIMENSIONI DIMENSIONS

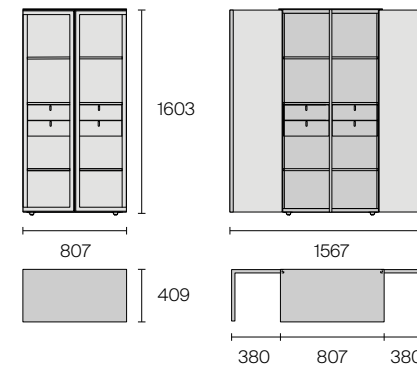

#### DESCRIZIONE TECNICA TECHNICAL DESCRIPTION

**EN** Aluminium structural thicknesses are minimized so that the transparent glass and the integrated LED lighting system can best enhance the objects on display. The doors are made of reflective glass and equipped with a key locking system. The internal shelves are in transparent grey glass, the aluminium structure is in bronzo finishing. Top, base, backpanel and central drawer unit are in noce wood. The drawer unit's top and the drawers' interior are equipped with synthetic leather available in 7 colours. The optional LED lighting is integrated under the shelves, top and drawer unit.

**IT** Gli spessori strutturali in alluminio sono ridotti al minimo, in modo che il vetro trasparente ed il sistema d'illuminazione a led integrato possano valorizzare al meglio gli oggetti esposti. Le ante sono realizzate in vetro riflettente chiaro e dotate di serratura di chiusura. I ripiani interni sono in vetro grigio trasparente, la struttura in alluminio è in finitura bronzo. Top, basamento, schienale e cassetiera centrale sono in noce. Il top cassetiera e l'interno dei cassetti sono dotati di rivestimento in similpelle disponibile in 7 colori. L'illuminazione led è opzionale ed è incorporata nei ripiani, nel top e sotto la cassetiera.

**RU** В этой модели из прозрачного стекла со встроенной светодиодной подсветкой толщина конструкции из алюминия сведена к минимуму, таким образом, выставленные в витрине предметы предстают в наиболее выгодном свете. Двери изготовлены из светлого зеркального стекла и оснащены замком. Внутренние полки выполнены из прозрачного серого стекла, алюминиевая конструкция представлена в отделке под бронзу. Top, основание, задняя стенка и центральный модуль с ящиками выполнены в отделке шпоном ореха, а топ модуля с ящиками и внутренняя поверхность ящиков обтянуты синтетической кожей: для данной модели предлагается 7 различных цветов. Модель предусматривает дополнительную опцию – светодиодную подсветку, которая может быть встроена во внутренние полки, топ и с нижней стороны модуля с ящиками.

**汉语** 铝质的结构厚度被缩减到最小, 使得透明玻璃和整合式led灯照明系统得以极致增添展示品的价值。门板采用亮色反光玻璃制成, 柜门带锁。内部层板为透明灰色玻璃, 结构为铝质带青铜色饰面。顶面、底座、侧板与中央抽屉皆为胡桃木。抽屉柜台面与抽屉内部覆以合成皮饰面, 可有7种颜色选项。Led照明为选购品, 将整合于层板中, 以及抽屉柜的顶部与底部。

#### FINITURE FINISHINGS

##### Struttura Structure

LACCATO METALLIZZATO  
LACQUERED METALIZED



303 bronzo

##### Top

VETRO METALLIZZATO  
METALIZED GLASS



136 bronzo opaco

##### Ante Doors

VETRO TRASPARENTE  
TRANSPARENT GLASS

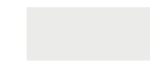

67 riflettente chiaro

##### Ripiano Shelf

VETRO TRASPARENTE  
TRANSPARENT GLASS



63 grigio trasparente

Top, basamento, schienale interno e cassetti in legno  
Wooden top, wooden base, internal back panel and wooden drawers unit

##### ESSENZA/WOOD



15 noce

Interno cassetti e top cassetiera  
Internal drawers and lower top

##### SIMILPELLE/SYNTHETIC LEATHER

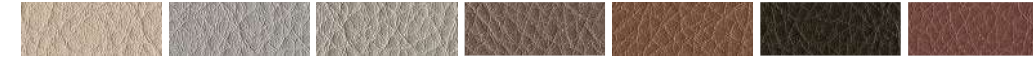

157 arena

158 agata

155 nube

154 argilla

153 castoro

159 etna

156 rubens

#### ALIANTE

ECOLORSYSTEM  
VETRO LACCATO/LACQUERED GLASS

GLOSSY MAT		GLOSSY MAT		GLOSSY MAT		GLOSSY MAT		GLOSSY MAT		GLOSSY MAT			
305	138 cipria	45	97 avorio	59	105 grigio chiaro	40	115 grigio cenere	53	95 bianco neve	50	108 bianco latte		
51	113 nocciola	52	107 corda	56	98 lino	312	145 grigio seta	47	96 grigio perla	78	114 sabbia		
306	139 terracotta	85	130 tufo	310	143 creta	38	121 azzurro cera	36	117 blu Londra	74	110 canapa		
76	116 rosso india	308	141 pepe	317	600 grigio artico	35	100 blu notte	39	122 verde inglese	73	109 giallo kashmir		
75	129 amaranto	309	142 sandalo	88	132 grigio scuro	86	131 blu oceano	314	147 verde lichene	43	119 laguna		
307	140 java	58	99 caffè	311	144 grigio lava	313	146 blu scuro	315	148 verde scuro	33	111 verde oliva		
		84	128 moro	46	102 nero					316	149 verde terra		

ECOLORSYSTEM  
VETRO SAHARA/SAHARA GLASS

505	cipria sahara	508	pepe sahara	520	grigio chiaro sahara	512	grigio seta sahara	514	verde lichene sahara	523	verde oliva sahara
506	terracotta sahara	509	sandalo sahara	517	lino sahara	522	blu oceano sahara	515	verde scuro sahara	516	verde terra sahara
507	amaranto sahara	519	caffè sahara	510	creta sahara	513	blu scuro sahara				
				524	grigio artico sahara						
				521	grigio scuro sahara						
				511	grigio lava sahara						

ECOLORSYSTEM  
VETRO METALLIZZATO/METALIZED GLASS

GLOSSY MAT		GLOSSY MAT		SAHARA		SAHARA		DIAMANTE		DIAMANTE			
304	137 platino	302	135 grafite	504	platino sahara	502	grafite sahara	404	platino diamante	402	grafite diamante		
69	126 palladio	303	136 bronzo	569	palladio sahara	503	bronzo sahara	469	palladio diamante	403	bronzo diamante		
83	127 piombo	300	133 rame	583	piombo sahara	500	rame sahara	483	piombo diamante	400	rame diamante		
301	134 peltro			501	peltro sahara			401	peltro diamante				

VETRO NEUTRO NEUTRAL GLASS		VETRO TRASPARENTE TRANSPARENT GLASS		VETRO SATINATO SATINATED GLASS		VETRO RETE MESH GLASS		VETRO REFLEX REFLEX GLASS			
55	specchio	590	trasparente sahara	67	riflettente chiaro	591	acidato sahara	60	rete alluminio	90	bianco reflex
68	specchio grigio	490	trasparente diamante	64	riflettente grigio	02	acidato extrachiaro	61	rete inox	92	kaki reflex
		05	trasparente extrachiaro	81	riflettente bronzo	01	acidato	62	rete bronzo	94	cacao reflex
		00	trasparente			03	acidato grigio	66	maglia gold	89	nero reflex
		63	grigio trasparente			04	acidato bronzo	87	maglia rame		
		65	bronzo trasparente			82	nuvola extrachiaro	06	fibra argento		
		390	verde trasparente			80	nuvola	08	fibra bronzo		
		391	blu trasparente								

ECOLORSYSTEM  
LACCATO OPACO/MAT LACQUERED



ECOLORSYSTEM  
LACCATO METALLIZZATO/LACQUERED METALIZED



ALLUMINIO GRAFFIATO  
SCRAPED ALUMINIUM



ALLUMINIO  
ALUMINIUM

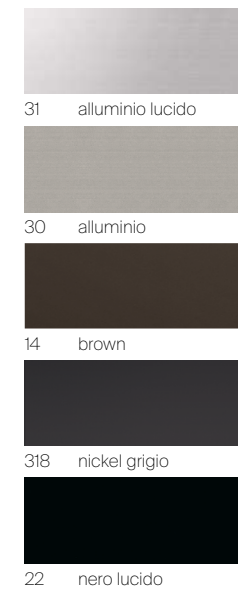

CUOIO  
LEATHER



SIMILPELLE  
SYNTHETIC LEATHER



TESSUTO LUX  
LUX FABRIC

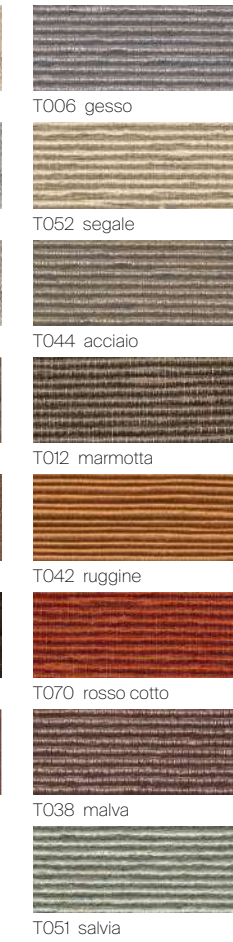

TESSUTO MATERIAL  
MATERIAL FABRIC



MARMO  
MARBLE



MARMO OPACO  
MAT MARBLE

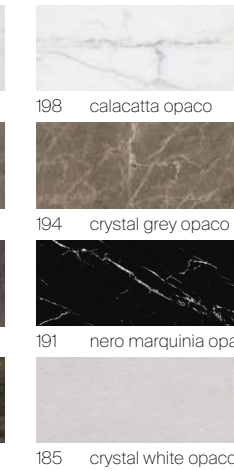

LITECH



ESSENZA  
WOOD



ESSENZA SAHARA  
SAHARA WOOD

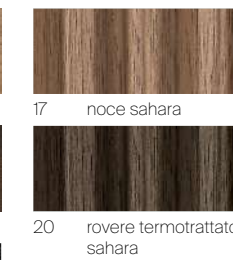

ESSENZA TAIGA  
TAIGA WOOD



MELAMINICO  
MELAMINE



MELAMINICO INTERNO  
INTERNAL MELAMINE



# TEXTS



THE GOOD LIVING  
P. 3

RU В новом каталоге The Good Living фабрика rimadesio представляет свой особенный взгляд на дизайн: здесь главная роль отведена новейшим технологическим разработкам, исследованиям материалов и уникальным производственным решениям. Это дизайн в духе современного образа жизни, новая идея, нацеленная на достижения идеального баланса между эмоциями, связанными с интерьером, и бережным отношением к окружающей среде.

汉语 通过The Good Living, 独特思维的Rimadesio设计正式登场。其中技术、精选材料与生产抉择都扮演着重要的角色。是一种启示新生活风格、理想维度以及实现我们居住情感与生活环境之间最佳均衡的设计。

LIVING  
STRIPE, ZENIT, TRAY, SELF PLAN, ALAMBRA, PLANET  
P. 8

RU Раздвижные двери Stripe отличает строгость дизайна и изысканность материалов. Они представляют собой практичную перегородку между входной зоной и большой светлой гостиной. Здесь, по обеим сторонам дивана, напротив друг друга располагаются библиотека zenit и подвесная композиция Self Plan. Эти системы идеально дополняют друг друга и создают гармоничную и функциональную композицию в современном стиле, отличающем все пространство.

汉语 严谨的设计与珍贵的材质, Stripe滑动门板为住宅入口玄关与敞亮的起居空间提供了实用的屏蔽。这里, 沙发区域的对面, 摆设了一座Zenit隔断式书架以及一套Self Plan墙面悬挂式收纳柜。这两套在功能上相辅相成的系列, 不但规划出井然有序的构图, 也赋予了空间现代化风格的特性。

DINING  
MODULOR, RADIUS, ALIANTE, FRANCIS  
P. 32

RU Новая отделка – шпон дуба с фактурной поверхностью taiga – предлагается как для стеновых панелей-буазери Modulor, так и для дверей Radius. Она подчеркивает изысканную обстановку столовой своим утонченным графическим рисунком. Стол Francis в круглом исполнении занимает центральное место в помещении, а расположенные по бокам от него тумбы Aliante из стекла подчеркивают его симметричную структуру. Сочетание этих моделей рождает светлый и гармоничный интерьер, в котором нет ничего случайного: от изысканного дизайна различных предметов интерьера до технического и функционального совершенства всех его элементов, от удобного и эргономичного открывания до изысканного сочетания материалов и отделки.

汉语 新推出并运用在Modulor装饰镶板以及Radius门的橡木Taiga饰面, 通过其细腻的图案设计, 为用餐区域增添精致。圆形版本的Francis桌, 摆在空间的中央, 而摆放在两边的Aliante玻璃边柜, 则营造出整体对称感。获得的成果是一个有一贯性又明亮的空间, 其中绝非偶然的细节包括: 从不同家具组件的精致设计, 到开启机制的高技术与功能性, 以及材料与饰面的讲究组合。

NIGHT  
SELF PLAN, SELF BOLD, RADIUS, PLANET  
P. 44

RU Композиция Self Plan, дополненная письменным столом с широкой столешницей, – это новый взгляд на пространство ночной зоны. Лаконичные и сдержанные низкие столики Planet можно использовать в качестве прикроватных, а двери Radius с отделкой из синтетической кожи объединяют пространство с зоной хранения в единое целое. Каждый из предметов интерьера выполняет свою конкретную роль, однако каждый из них вносит свой вклад в формирование единого цельного пространства, объединенного цветовыми и текстурными решениями, лаконичностью дизайна и тончайшей проработкой каждой детали.

汉语 增添了宽敞的写字平台, Self Plan提出了一种不同形态又丰富卧室空间的组合。实质又含蓄, 两张Planet矮桌成为床的辅助元素, 而合成皮的Radius门, 连接了卧室空间与衣柜区域。偕同其特定功能, 每个家具组件皆通过色彩、材料的纹理、图样的本质特色以及精致的每处细节, 定义出整体的一致性风格。

WALK-IN CLOSET  
ZENIT, COVER  
P. 54

RU В обрамлении стен, созданных из встроенных шкафов Cover, в зоне гардеробной центральное место занимает композиция zenit. Распашные двери системы cover, в отделке яркой и светлой синтетической кожей в цвете arena, великолепно оттеняют бронзовую отделку структуры гардероба Zenit. Внутреннее оснащение, усовершенствованное по сравнению с предыдущими версиями, позволяет оригинально и функционально решить повседневные задачи по организации внутреннего пространства.

汉语 Cover衣柜隐身于持续性墙面中, 在这个衣帽间的中央, 摆设了一套Zenit, 于此, 以步入式衣柜间的版本呈现。明亮Arena合成皮覆面的Cover面板, 成了衬托青铜色铝质饰面Zenit的背景。而配置了更新版功能性配备的Zenit, 以原创性的特色, 发挥着不同功能之规划与收纳的典型需求。

Collection designed by Giuseppe Bavuso

THE GOOD LIVING

Concept and art direction: Juma

Render: Inside Group Technology

Styling: Simona Silenzi Studio with Gaia Marchesini, Giordano Sarno

June 2022

RIMADESIO SPA  
Via Furlanelli 96  
20833 Giussano (MB) Italy  
T +39 0362 3171  
rimadesio@rimadesio.it

MILANO FLAGSHIP STORE  
via Visconti di Modrone 26  
20122 Milano Italy  
T +39 02 76280708  
milano@rimadesio.it

LONDON FLAGSHIP STORE  
83-85, Wigmore street  
1WU 1DL London  
T +44 2074 862193  
london@rimadesio.co.uk

NEW YORK FLAGSHIP STORE  
102 Madison Ave  
New York, NY 10016  
T +1 917 388 2650  
newyork@rimadesio.us

[www.rimadesio.it](http://www.rimadesio.it)

Italy showroom:

Milano, Roma, Genova, Torino, Como, Parma, Firenze, Palermo, Catania, Cosenza, Salerno.

Worldwide showroom:

Oxford, Genève, Bern, Lucerne, Wien, Frankfurt, Hamburg, Munich, Nice, Madrid, Barcelona, Bilbao, Marbella, Moraira, Valencia, Vigo, Bruxelles, Moscow, Saint Petersburg, Istanbul, Kiev, Odessa, Beirut, Nicosia, Tokyo, Seoul, Shanghai, Wuxi, Ningbo, Suzhou, Zhengzhou, Guangzhou, Shenzhen, Dongguan, Hong Kong, Taipei, Manila, New Delhi, Ahmedabad, Bangalore, Riyadh, Kuwait City, Casablanca, New York, Chicago, Miami, Houston, Mexico City, Bogotá, Cape Town, Sydney, Melbourne.

Awards

1993	Siparium	Young & Design
2000	Zenit	Award KBB
2001	Zenit	selection Design Index ADI
2002	Siparium	Top100 Frames
2005	Graphis	selection Design Index ADI
2007	Vela	selection Design Index ADI
2008	Vela	mention XXI Premio Compasso d'Oro ADI
2015	Wind	winner Red Dot Award
2016	Cover	Best Furniture System AZ Award
2016	Alambra	selection Design Index ADI
2017	Sail	selection Design Index ADI
2017	Soho	Architectural products AZ awards
2017	Daimon	Interior Design Magazine Best of Year awards
2020	Modulor	People's Choice winner AZ Awards
2020	Modulor	Architectural Products Award of Merit AZ Awards
2020	Modulor	selection Design Index ADI
2021	Francis	selection Design Index ADI

Modelli depositati e brevettati/Patented:

Aliante, Radius, Maxi, Sail, Soho, Velaria, Stripe, Daimon, Graphis, Siparium, Zen, Zen frame, Moon, Vela, Luxor, Even, Aura, Spin, Link+, Planet, Flat, Alambra, Abacus living, Self, Cover, Zenit, Dress bold e Abacus.

Marchi registrati/Registered trademarks:

Rimadesio, Ecolormsystem, Litech, Siparium, Velaria, Abacus.



Follow us on Facebook, Instagram, WeChat.